



Assembly instructions

FRIALEN safety fittings
for sustainable pipes for gas, water networks
and industrial systems made of PE



Table of Content

- 1. About this document9
 - 1.1. Objective and target group of these instructions 9
 - 1.2. How to use these instructions 9
 - 1.3. Symbols used 9
 - 1.4. Applicable relevant documents 10
 - 1.5. Updates to these assembly instructions 10

- 2. Safety 11
 - 2.1. Designated, intended use 11
 - 2.2. Note on pipes which are not underground 11
 - 2.3. Staff training 11

- 3. Processing information 12
 - 3.1. Pressure bearing capacity 12
 - 3.2. Environmental, storage and processing conditions 13

- 4. Standards and certification 14

- 5. Product description and product overview 14
 - 5.1. Product description 14
 - 5.2. Product overview 15

- 6. Marking on the component 15
 - 6.1. Batch identification 15
 - 6.2. Barcode sticker: Fusion and traceability 15
 - 6.2.1. Barcode for fixed-voltage fusion unit (39.5V) 16
 - 6.3. Barcode sticker: Pre-heating 17

- 7. Processing the FRIALEN safety fittings 18
 - 7.1. Preparatory work 18
 - 7.2. Cutting the pipe to length (couplers and moulded parts) 18

7.3.	Cleaning the pipe	19
7.4.	Measure and mark the fusion zone	19
7.5.	Applying marking lines	20
7.6.	Removing the oxide layer	20
7.7.	Deburr the cut edge	23
7.8.	Re-rounding non-round, oval pipes	23
7.9.	Cleaning the joint surface areas	24
7.10.	Mark the fusion zone again	26
8.	Assembly and processing: Couplers and moulded parts	26
8.1.	Assembling couplers and moulded parts	26
8.2.	Fusion process	27
8.2.1.	Contacting the fusion unit	28
8.2.2.	Pre-heating	28
8.2.3.	Reading the barcode and start the fusion process	29
8.2.4.	Designation marking of the fusion joint and decontacting the fusion unit	32
8.2.5.	Repeating the fusion process	32
8.2.6.	Cooling time	32
9.	FRIASTOP Gas-Stop Unit	34
9.1.	About the product	34
9.2.	Product description	35
9.2.1.	FRIASTOP M Gas-Stop Unit	35
9.2.2.	FRIASTOP P Gas-Stop Unit	35
9.3.	Preparatory work and installation	36
9.4.	Commissioning	36
10.	Ball valves	37
10.1.	About the product	37
10.2.	Product description	37
10.2.1.	Ball valve for gas	37
10.2.2.	Ball valve for water	38

- 10.3. Preparatory work and installation38
- 10.4. Commissioning 39

- 11. FRIALOC PE Shut-Off Valve 39
 - 11.1. About the product 39
 - 11.2. Product description 40
 - 11.3. Preparatory work and installation 40
 - 11.4. Commissioning 42

- 12. Processing saddle components with under clamp45
 - 12.1. About the product45
 - 12.2. Preparatory work, assembly and installation 45
 - 12.3. Commissioning 46
 - 12.3.1. Commissioning the DAP pressure tapping tee with parallel dome .46
 - 12.3.2. Commissioning the AKHP tapping ball valve for side tapping gas under pressure 47
 - 12.3.3. Commissioning the SA saddle with spigot 48
 - 12.3.4. Commissioning the saddle with SAFL flange 49
 - 12.3.5. Commissioning the SPA balloon shut-off saddle 50
 - 12.3.6. Commissioning the valve tapping saddle with HD-PE/gunmetal adapter VAM RG 51

- 13. Processing saddle components for top-loading 52
 - 13.1. About the product 52
 - 13.2. Preparatory work, assembly and installation52
 - 13.3. Commissioning53
 - 13.3.1. Commissioning the AKHP TL tapping ball valve Top-Loading for side tapping gas under pressure 54
 - 13.3.2. Commissioning the SPA TL top-loading balloon shut-off saddle ...54
 - 13.3.3. Commissioning the valve tapping saddle top-loading with HD-PE/gunmetal adapter VAM RG TL 55

- 14. Pressure tapping tees and pressure tapping valves 56
 - 14.1. DAA RED SNAP Pressure Tapping Tees 56

- 14.1.1. About the product56
- 14.1.2. Product description57
- 14.1.3. Preparatory work and installation 57
 - 14.1.3.1. Assembly in confined spaces 59
- 14.1.4. Fusion60
- 14.1.5. Tapping and commissioning61
 - 14.1.5.1. Installing the domestic service line62
 - 14.1.5.2. Pressure test 62
 - 14.1.5.3. Tapping67
 - 14.1.5.4. Access protection for the tapping dome 70
- 14.2. Top-Loading DAA TL Pressure Tapping Tees 71
 - 14.2.1. About the product71
 - 14.2.2. Product description71
 - 14.2.3. Processing 71
 - 14.2.4. Fusion73
 - 14.2.5. Tapping and commissioning74
 - 14.2.5.1. Installing the domestic service line74
 - 14.2.5.2. Pressure test74
 - 14.2.5.3. Tapping74
 - 14.2.5.4. Access protection for the tapping dome75
- 14.3. DAV RED SNAP Pressure Tapping Valves76
 - 14.3.1. About the product76
 - 14.3.2. Product description76
 - 14.3.3. Preparatory work and installation76
 - 14.3.3.1. Assembly in confined spaces 78
 - 14.3.4. Fusion78
 - 14.3.5. Tapping and commissioning 80
 - 14.3.5.1. Installing the domestic service line 80
 - 14.3.5.2. Pressure test80
 - 14.3.5.3. Tapping81
 - 14.3.5.4. Commissioning82
- 14.4. Top-Loading DAV TL Pressure Tapping Valves 84

14.4.1.	About the product	84
14.4.2.	Product description	84
14.4.3.	Processing	84
14.4.4.	Fusion	85
14.4.5.	Tapping and commissioning	86
14.4.5.1.	Installing the domestic service line	86
14.4.5.2.	Pressure test	86
14.4.5.3.	Tapping	87
14.4.5.4.	Commissioning	87
15.	Saddle with spigot, top-loading	88
15.1.	About the product	88
15.1.1.	Clamping unit scope of delivery	88
15.2.	Product description	89
15.3.	Preparatory work and installation	89
15.3.1.	Assembling the saddle on the pipe	89
15.4.	Tapping and commissioning	91
16.	Saddle with spigot, universal	92
16.1.	About the product	92
16.1.1.	Clamping unit UNITOP scope of delivery	92
16.1.2.	Clamping unit UNITOP 250 scope of delivery	93
16.2.	Product description	94
16.2.1.	SA UNI	94
16.2.2.	SA UNI 225 - 250	94
16.3.	Preparatory work, assembly and installation with the clamping unit	94
16.3.1.	Assembling the saddle SA UNI on the pipe	95
16.3.2.	Assembling the UNITOP clamping unit	96
16.3.3.	Assembling the saddle SA UNI 225 - 250 on the pipe	99
16.3.4.	Assembling the UNITOP 250 clamping unit	101
16.4.	Actuating the UNITOP clamping unit	103
16.5.	Actuating the UNITOP 250 clamping unit	105

16.6.	Fusion	107
16.7.	Dismantling the UNITOP clamping unit	109
16.8.	Dismantling the UNITOP 250 clamping unit	110
16.9.	Pressure test	112
16.10.	Tapping and commissioning	114
16.10.1.	Tapping the pipe (unpressurised)	114
16.10.2.	Tapping the pipe (under pressure)	115
16.10.3.	Commissioning	118
16.11.	Care and maintenance	118
17.	Saddle with spigot, vacuum loading	119
17.1.	About the product	119
17.1.1.	Clamping unit scope of delivery	119
17.2.	Product description	120
17.3.	Preparatory work, assembly and installation with the clamping unit	120
17.3.1.	Assembling the saddle on the pipe	121
17.3.2.	Assembling the PUMP	122
17.4.	Clamping via vacuum generation	123
17.5.	Fusion	124
17.6.	Dismantling the clamping unit	125
17.7.	Tapping and commissioning	126
17.7.1.	Tapping the pipe (unpressurised)	126
17.7.2.	Tapping the pipe (under pressure)	127
17.7.3.	Commissioning	128
17.8.	Care and maintenance	128
18.	Repair and reinforcing saddles	129
18.1.	About the product	129
18.2.	Product description	130
18.3.	Preparatory work and installation	131
18.3.1.	Assembly with under clamp	132
18.3.2.	Assembling with the clamping unit	133

- 19. Retaining residual water 135
 - 19.1. Repair sleeve 135
 - 19.2. Repair Balloon 136

- 20. Transition piece 137
 - 20.1. About the product 137
 - 20.2. Product description 138
 - 20.3. Assembling the transition piece 142
 - 20.3.1. Assembling transition pieces with threaded connection 142
 - 20.3.2. Assembling the transition piece with steel pipe and copper pipe . 142

- 21. Fixation (FIXBLOC) 143
 - 21.1. About the product 143
 - 21.2. Product description 143
 - 21.3. Preparatory work, assembly and installation with the tensioning belt 144
 - 21.3.1. Assembling the FIXBLOC with the tensioning belt on the pipe 144
 - 21.3.2. Fusion 146
 - 21.3.3. Dismantling the tensioning belt 147
 - 21.4. Preparatory work, assembly and installation with the clamping unit 147
 - 21.4.1. Assembling the FIXBLOC with the clamping unit on the pipe 147
 - 21.4.2. Fusion 150
 - 21.4.3. Dismantling the clamping unit 150

1. About this document

1.1. Objective and target group of these instructions

These instructions describe all the necessary work steps and precautionary measures which must be implemented in order to ensure safe and professional handling of the product and/or assembly.

These instructions are intended for the following target group:

- Trained fitters
- Operators and/or owners

1.2. How to use these instructions

i INFO

- Always read these instructions carefully before assembling and using the products.
 - Always observe any other applicable documents.
 - The owner/operator must always retain these instructions for the service life of the product.
 - The described sequence of working steps must always be adhered to.
-

1.3. Symbols used

The following marks and symbols are utilised in this document:

⚠ DANGER

This warning information describes an imminent danger.

- ▶ Non-compliance will lead to death or serious injuries.

⚠ WARNING

This warning information describes a possible imminent danger.

- ▶ Non-compliance can lead to death or serious injuries.

⚠ CAUTION

This warning information describes a possible imminent danger.

- ▶ Non-compliance can lead to slight or minor injuries.

HINT

This warning describes a danger which can lead to property damage.

- ▶ Measures to prevent property damage will be described here.

i INFO

This note provides information about the following subjects:

- Application tips
- Further information

1.4. Applicable relevant documents

The following documents also apply in connection with these assembly instructions:

- FRIATOOLS and FRIAMAT operating instructions from Aliaxis Deutschland GmbH for handling, preparing and processing the components described.
- Technical Data Sheets from Aliaxis Deutschland GmbH,
- Brief instructions and product information enclosed with the product.

When processing components which are not described in these assembly instructions, please always refer to the corresponding product-specific assembly instructions.

1.5. Updates to these assembly instructions

These technical statements are regularly reviewed in order to ensure that they are up to date.

The date of the last revision is indicated on the document.

Updated instructions can be found on the Internet at

<https://www.aliaxis.de/en/downloads>

2. Safety

2.1. Designated, intended use

FRIALEN safety fittings, which are made of PE 100, from Aliaxis Deutschland GmbH are utilised for fusion joints on polyethylene pressure pipes in gas networks and water distribution, pressurised drainage, industry and landfill construction.

Our „H2 ready“ marked products are suitable for applications in pipes for hydrogen containing, methane-enriched gas or hydrogen.

FRIALEN safety fittings are fusion-capable with PE pipes according to the specifications of the SDR pipe series on the barcode sticker of the respective fitting.

i INFO

Please contact Aliaxis Deutschland GmbH for preparing or processing pipes with a different wall thickness or SDR. If you intent to operate with media other than potable water and natural gas, then please contact our hotline, Aliaxis Deutschland GmbH, telephone number: +49 621 486-1486.

2.2. Note on pipes which are not underground

i INFO

Please contact the hotline from Aliaxis Deutschland GmbH, telephone number: +49 621 486-1486 for pipes which are not underground.

These assembly instructions primarily describe the technical requirements for the underground installation of PE pipes. An extended application scope (e.g. in the industrial sector) requires specific knowledge for planning, design, execution, assembly and installation.

In addition to individual load cases, the special project planning and design principles for industrial pipes or pipelines (e.g. DVS 2210-1 et. sec.) must always be observed.

Deviations could result in a reduced service life for the pipe system with spontaneous failure, breakage and leakage.

2.3. Staff training

All the people who are involved with, or assigned to, work, preparation, processing and the intended use, must always fulfil the following prerequisites:

- They must have been provided with a training course or instructions for assembling the products and the required tools.

- Qualification as a PE welder, fusion expert e.g. in accordance with DVGW GW 330.
- They must have read and understood these assembly instructions and all other applicable documents.

3. Processing information

3.1. Pressure bearing capacity

The pressure bearing capacity of the FRIALEN safety fittings made from PE 100 will be specified by the marking with **SDR** (Standard Dimension Ratio). It is the coefficient which specifies the relationship between the external diameter and wall thickness for a pipe.

$$\text{SDR} = \text{Pipe external-}\varnothing d / \text{Pipe thickness } s$$

The design factor C (calculation coefficient for components made from PE) is dependent on the area of application and specific specifications (min. 1.25).

PE 100 moulded part SDR range	Water Maximum working pressure in bar at C = 1.25	Gas Maximum working pressure in bar at C = 2
26	6	--
17	10	5
11	16	10
9	20	--
7.4	25	--

i INFO

When using other PE pipe materials (e.g. PE 80), a pressure reduction to the maximum working pressures which are specified above may need to be observed.

The fusion fittings are labelled and can be used in accordance with the table above with regard to their pressure resistance.

Always consider any reduction factors e.g. at operating temperatures > 20 °C.

In the case of pressure classifications which can deviate from this identification marking e.g. due to functional restrictions with FRIASTOP (coupler with integrated gas-stop unit), then the information on the fitting or in the technical documentation must always be observed.

i INFO

In the case of any deviating operating conditions, please contact the hotline of Aliaxis Deutschland GmbH, telephone number: +49 621 486-1486.

3.2. Environmental, storage and processing conditions

i INFO

Improperly stored components must never be processed because they can result in a leaking fusion joint.

Storage conditions:

- In closed rooms or containers (e.g. in cardboard boxes)
- Protect from UV radiation
- Protect against the effects of weather such as moisture and frost
- Storage temperatures: up to +50 °C

Under these prerequisites, a storage capability and processing life of more than ten years can therefore be assumed.

i INFO

For couplers from d 250, always ensure that they are stored lying on the front edge in order to prevent ovality of the couplers.

i INFO

Always control that the component has been delivered in perfect condition before processing it. Damaged components must never be installed.

Processing conditions:

i INFO

The pipes and moulded parts should always be at an even temperature level during processing.

- Permissible processing range: -10 °C to +45 °C
 - Processing range for couplers from d 710: 0 °C to +45 °C
 - > 0 °C for PE-LD pipes
-

- For PE pipes, a melt flow rate MFR 190/5 in the range from 0.2 to 1.7 g/10 min. applies.
- Processable with pipes of raw material types PE 63, PE 80, PE 100, PE 100 RC and PE 100 RT
- Processing with pipes of raw material type PE-Xa on request

4. Standards and certification

FRIALEN safety fittings, which are produced from PE 100 by Aliaxis Deutschland GmbH, are components for PE pressure pipes which are described in system standards. The components fulfil the requirements stated in this standard and can be universally utilised within the system for

- gas distribution in accordance with EN 1555 and ISO 4437 as well as for
- potable water distribution and/or for general pressure applications in accordance with EN 12201 and ISO 4427.

Hygienic suitability for potable water applications has been verified, including in accordance with the requirements of the European Drinking Water Ordinance as well as for other national specifications, e.g. for Germany in accordance with the UBA-KTW assessment principles.

A large proportion of the FRIALEN safety fittings have been FM-approved by FM Global Group. The list for FM-approved components can be found in the relevant certificate on the Aliaxis Deutschland GmbH homepage https://www.aliaxis.de/website/downloads/friatec/de/zertifikat/zertifikat_friatec_fm-certificate.pdf

Furthermore, FRIALEN safety fittings fulfil the requirements of national product standards. This has been confirmed by a large number of national and international certificates.

5. Product description and product overview

5.1. Product description

These assembly instructions will describe the processing and installation of FRIALEN safety fittings with PE pipes based on electrofusion technology.

FRIALEN safety fittings can be processed with universal fusion units and equipment e.g. the FRIAMAT series from Aliaxis Deutschland GmbH.

In addition to our assembly instructions, the material-specific or system-specific standards and assembly guidelines apply to material-transfer joints e.g. screwed connections, fusion joints or welds, particularly with regard to sealing, heat penetration during steel fusion and corrosion protection.

5.2. Product overview

These assembly instructions will describe the processing of FRIALEN safety fittings from Aliaxis Deutschland GmbH, such as:

- Couplers and moulded parts (such as reducers, caps, elbows, T-pieces and Y-pieces)
- Gas-Stop units (FRIASTOP and MR STOP)
- Ball valves
- PE shut-off valve (FRIALOC)
- Pressure Tapping Valves
- Pressure Tapping Tees
- Balloon Shut-off Saddles
- Saddle moulded parts with spigot (Top-Loading, Universal and Vacuum-Loading)
- Repair and reinforcing saddles
- Transition piece
- Fixation (FIXBLOC)

6. Marking on the component

6.1. Batch identification

The component is provided with a batch identification.

This should be read from left to right.

Example:



- Production week (CW) (Stamp 1+2).
 - Year of manufacture (Stamp 2)
 - Material code letter (Stamp 3)
- ⇒ CW 14/2019/E

Some components are marked directly in reading mode.

Image 1:

6.2. Barcode sticker: Fusion and traceability

FRIALEN safety fittings are all provided with a barcode sticker.



Image 2:

Top barcode (fusing barcode according to ISO 13950):

The fusing parameters are included in the main barcode. The parameters are entered into the fusion unit by utilising a reading wand or mini scanner or via smartphone using the WorkFlow procedure. The 24-digit number sequence can be entered manually into the fusion unit via the emergency input mode. The fusion unit always automatically monitors the fusion process and thereby regulates the introduced energy in specified limiting values.

The barcode stickers will be gradually provided with a 2D barcode in accordance with ISO 12176-5 on all FRIALEN safety fittings. This new 2D barcode will therefore provide various advantages for the user: Just one reading process using a 1D/2S scanner or Smartphone will mean that a lot of important data can be read out quickly and securely, for example, in addition to fusion data, additional information about the product, the manufacturer or traceability.

Lower barcode (traceability barcode according to ISO 12176-4):

Data relating to the fitting, e.g. manufacturer, dimension, material, batch are contained in this barcode and therefore enable traceability (component traceability). This data can be electronically archived together with the fusion parameters. Suitable fusion units are always required for this purpose. The 26-digit number sequence can be entered manually into the fusion unit via the emergency input mode.

6.2.1. Barcode for fixed-voltage fusion unit (39.5V)



Some FRIALEN safety fittings can also be processed by fusion units with a fixed output voltage of 39.5V, when the fusion time is entered manually. The fusion time is specified on the barcode for manual input of the fusion parameters.

Image 3:

i INFO

Should you have any queries about which FRIALEN fusion fittings are suitable for processing with fixed-voltage fusion units, then please always contact the Aliaxis Deutschland GmbH hotline on +49 621 486-1486.

i INFO

If fixed-voltage fusion units are to be utilised, then the permissible processing range is ambient temperatures from $-5\text{ }^{\circ}\text{C}$ to $+35\text{ }^{\circ}\text{C}$. The fusion time specified on the barcode sticker will always apply for the entire temperature range!

i INFO

Due to the differences between fusion work with fixed (39.5V) and variable voltage, there can be differences in the fusion time details which are indicated on the barcode sticker and/or the assembly instructions and the display located the FRIAMAT fusion unit. **The display which is located on the FRIAMAT fusion unit is always decisive.**

6.3. Barcode sticker: Pre-heating



Image 4:

A barcode sticker for pre-heating (yellow barcode sticker) is attached on the component in the case of coupler **UB \geq d 400**, **UB PN25 \geq d 280** and saddle with spigot **SA VL** in addition to the barcode sticker (white barcode sticker) with the barcode entered on it for fusion and traceability. With the help of the specially matched pre-heating barcode, the annular gap between the coupler and pipe can be compensated for within certain limits.

i INFO

Please refer to the "Fusion Process" / "Preheating" chapter and/or the instruction leaflet for the respective coupler for more information on the preheating barcode and handling of preheating.

7. Processing the FRIALEN safety fittings

i INFO

The described sequence for the working steps in these assembly instructions must always be adhered to!

7.1. Preparatory work

Prepare the fusion joint according to the following work steps (e.g. remove oxide layer, cleaning work etc.).

7.2. Cutting the pipe to length (couplers and moulded parts)

⚠ WARNING

Fusion coils which are not completely covered by the pipe will lead to overheating, uncontrolled melting or spontaneous combustion.

Danger created by burns

- ▶ Cut the pipe at right angles to the pipe axis.

Cut the pipe at right angles to the pipe axis. A PE pipe cutting tool or a saw with plastic-compatible teeth are suitable.

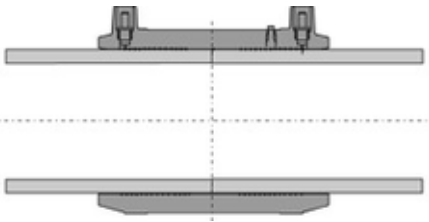

Image 5:

- Right-angled pipe cutting

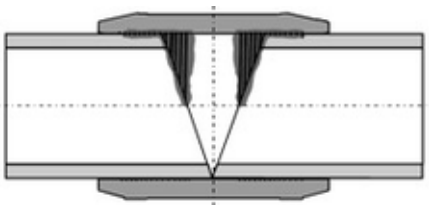

Image 6:

- Pipe not cut at right angles



7.3. Cleaning the pipe



Image 7:

- Roughly remove dirt and dust from the pipe in the area of the fusion zone.
- Cleaning material: absorbent, non-linting and not dyed paper.

7.4. Measure and mark the fusion zone



Image 8:

Fusion zone: The insertion depth for couplers and/or moulded parts is generally half the coupler length, or the insertion depth for fittings. For couplers without internal stops, always the dimension between coupler edge and coupler centre.



Image 9:

Fusion zone: The pipe surface area covered by the saddle with saddle moulded parts.

i INFO

We recommend adding a machining supplement of approx. +5 mm to the fusion zone. This is the verification that the oxide layer has been properly removed after the fusing process.

7.5. Applying marking lines



Image 10:

Mark the fusion zone with a suitable marker.

We always recommend that marking (control) lines are applied for controlling that the surface has been removed completely and without gaps.

If there are any areas on the pipe surface which have not been scraped off during oxide layer removal, then these must always be reworked.

7.6. Removing the oxide layer

▲ CAUTION

Danger of injury from rotating scraper tools.

Injuries to hands or on the arm area.

Always observe the relevant operating instructions and the manufacturer's instructions.

Never reach into the working area of the tool.

▲ CAUTION

Danger of injury from the scraper blade!



Image 11:

Using a (rotary) scraper tool e.g. a FRIATOOLS scraper tool FWSG, FWSG RA, FWSG SE or, for large pipes, the scraper chain FWSK d 250 to d 1000 or the FWSG XL d 800 to d 1200, will ensure the oxide layer which has formed on the surface of PE pipes or PE spigot fittings during storage will always be completely removed immediately before assembly or installation.



Fig. Top: Oxide layer removal on the pipe end with the FWSG scraper tool

Fig. Middle: Oxide layer removal on the saddle surface area with the FWSG SE scraper tool

Fig. Bottom: Oxide layer removal with the FWSK scraper chain

Image 12:



Image 13:

i INFO

If the oxide layer is not completely removed, then a leaking fusion joint can result.

i INFO

Filing or sanding the pipe is not permitted because impurities will be rubbed in.

The result achieved with scraping must be inspected. A one-off, complete removal is sufficient (at least 0.15 mm). Damage to the pipe surface area e.g. axial grooves or scratches must not be located in the fusion zone.

Excessive scraping actions or swarf removal can lead to a large annular gap which cannot be closed or not completely closed during fusing. Please therefore regularly inspect the condition of the scraper blade on the scraper tool as well as the swarf thickness s by utilising a calliper gauge and compare the value with the information below in the table. Worn blades must always be replaced!

The following table shows the permissible nominal swarf thickness s [mm] and the wear limit s_{\max} [mm] for FRIALEN Safety Fittings from Aliaxis Deutschland GmbH. Please always observe the corresponding manufacturer's specifications when utilising other moulded fitting brands.

Pipe diameter d [mm]	Scraper tool FRIATOOLS	Target swarf thickness s [mm]	Wear limit s_{\max} [mm]	
d 32 - d 63	FWSG, -RA, -SE	0.15 - 0.25	0.3	
d 75 - d 225	FWSG, -SE	0.15 - 0.35	0.4	
d 75 - d 400	FWSG	0.25 - 0.35	0.5	
d 250 - d 710	FWSG, -SE	0.30 - 0.45	0.5	
d 250 - d 1000	FWSK	0.25 - 0.35	0.5	
d 800 - d 1200	FWSG XL	0.40 - 0.60	0.8	

i INFO

The prepared area must always be protected against dirt, soap, grease, water and unfavourable weather conditions (e.g. moisture, frost).

i INFO

The swarf which is created during oxide layer removal, as well as all cleaning agents and packaging materials, must be disposed of properly. Also observe all country-specific regulations, standards and guidelines.

7.7. Deburr the cut edge

After cutting the pipe (coupler, moulded parts assembly), deburr the cut edge on the outside and inside.

A hand scraper is useful for this task. Slight chamfering of the pipe face-end edge on the outer diameter will facilitate the assembly work of the FRIALEN safety fitting and prevents damage to the fusion fitting due to sharp edges when inserting it.

i INFO

Always remove any swarf from the pipe which could have resulted from the deburring process.

7.8. Re-rounding non-round, oval pipes

▲ WARNING

Danger of injury from crushing.

If the rounding clamp is handled incorrectly, then the hands or fingers can be trapped when assembling, fitting and actuating the rounding clamp.

- ▶ Always observe the operating instructions for the unit and the manufacturer's specifications when assembling, installing and operating the rounding clamp.
- ▶ Always wear protective gloves for protection during assembly work.
- ▶ Never place your hand or fingers between the pipe and the rounding clamp.
- ▶ Never place your hand or fingers between the unit components.



Image 14:

Pipes, especially those coming from coils and drums, can become non-round or oval during storage. If this should prove to be the case, then they must be rounded back to their original shape when the pipe ovality in the area of the fusion zone is more than 1.5% of the external diameter or ≥ 3.0 mm.

Utilise rounding clamps or rounding bars, e.g. FRIATOOLS rounding clamps or similar, which must be positioned at the end of the fusion zone.

7.9. Cleaning the joint surface areas

▲ CAUTION

Skin contact with cleaning agent

Degreasing the skin, dehydration

- ▶ Always wear protective gloves.
- ▶ Utilise in metered quantities.
- ▶ Follow the manufacturer's safety instructions.



Image 15:



Image 16:

The surfaces of the pipe

- to be fused and
- the (internal) surface areas of the FRIALEN safety fitting to be processed

must always be absolutely clean, dry and free of grease.

Clean these surfaces immediately before assembly or installation and after oxide layer removal with a suitable cleaning agent and only with absorbent, lint-free and non-dyed paper.

i INFO

If cleaning agents containing alcohol are utilised, then the alcohol content must be at least 99.8 %, e.g. in accordance with DVGW-VP 603.

We recommend PE cleaning agents e.g. those which have been approved in accordance with the DVGW-VP 603 testing basis e.g. AHK cleaner.

Always prevent rubbing soiling, contamination or dirt from the unscraped pipe surface from entering into the fusion zone when cleaning. The cleaning agent must have evaporated completely before fusing. Touching the cleaned fusion zone with your hand must be prevented. Any moisture e.g. arising from dew or frost in the area of the fusion zone, must be removed with suitable aids.

i INFO

Only remove the fusion fitting to be processed from the packaging immediately before the intended processing. The packaging is intended to protect the fusion fitting against external influences during transport and storage.

7.10. Mark the fusion zone again

Subsequently mark the fusion zone, i.e. the marking lines for the insertion depth for couplers, moulded parts and fittings or the saddle surface for saddle fittings, on the pipe again with a marker, as these were removed during oxide layer removal and cleaning.

8. Assembly and processing: Couplers and moulded parts

8.1. Assembling couplers and moulded parts

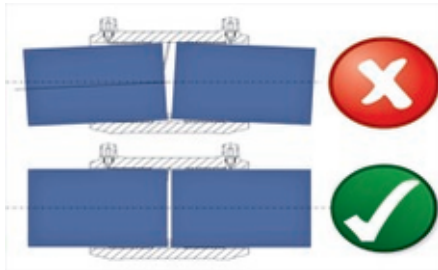

Image 17:

Do not tilt the FRIALEN coupler or moulded part when connecting it to the pipe.

All joints which are to be prepared for fusion must be tension-free. Pipes must never be exposed to bending stress or dead load in the fusion fitting. The fusion fitting must be able to be pushed on without force.



Image 18:

Assembling the coupler with large pipe diameters can be supported with light taps with a rubber mallet on the circumference of the coupler opening when necessary.

i INFO

Always hereby pay attention to the fusion contacts on the coupler.

i INFO

A joint or connection point, which is not created as tension-free and/or is displaced, can lead to impermissible melt flow during the fusion process and to a faulty connection.

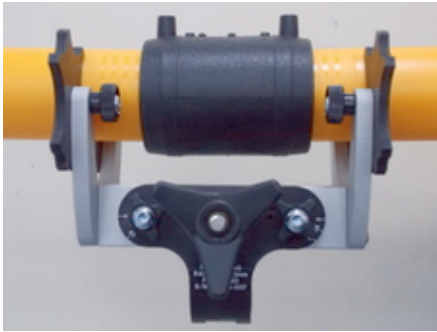

Image 19:

If considered applicable, the pipe or the fusion fitting must be supported or suitable alignment clamps must be utilised.

Please utilise e.g. FRIATOOLS pipe alignment clamps or similar methods.

i INFO

Always maintain the tension-free fixation of the joint or connection point until the cooling time specified on the barcode has been reached.

Inspect again by utilising the marking lines on the pipe in order to ensure that the position of the pipe insertion end in the fusion fitting has not been displaced before commencing the fusion work (correct if necessary).

If it is still not possible to push the fusion fitting on without force, despite the previous procedure, then a repeated scraping process is permitted. Repeated scraping must never be executed in order to rectify assembly problems caused by ovality! In this case, a simple control of the high points is possible by fitting the fusion fitting and subsequently assessing the annular gap. Subsequent scraping of the high points is permitted.

8.2. Fusion process

i INFO

Only utilise fusion units and equipment which has been approved by the manufacturer for the processing of FRIALEN safety fittings from Aliaxis Deutschland GmbH, e.g. FRIAMAT fusion units, equipment or similar. Please refer to DVS 2207-1 and ISO 12176-2.

i INFO

FRIAMAT fusion units must never be operated when not supervised!

The fusion unit operator must always remain within sight of the unit, as well as the fusion fitting which is to be processed, during the fusion process.

8.2.1. Contacting the fusion unit



Image 20:

Always ensure that the fusion contacts on the fusion fitting are easily accessible and that loads, stresses or strains caused by the fusion cable on the fusion jointing are prevented when assembling the fusion fitting.

Create a contact for the fusion cable with the fusion plugs to the contact plugs of the fusion fitting. The fusion plugs must always be completely connected to the contact plugs of the fusion fitting i.e. over the entire length of the internal contact.

i INFO

Always observe whether the fusion fitting to be processed has a continuous fusion wire winding (monofilar winding) or separate fusion wire windings (bifilar winding) located on each side of the fusion fitting when creating a contact for the FRIALEN safety fitting.

- **Monofilar Winding:** Both fusion fitting sides will be fused simultaneously.
- **Bifilar Winding:** Every fusion fitting side will be fused separately.

i INFO

In the case of **UB ≥ d 1000** couplers, only FRIAMAT XL fusion units must be utilised.

Always observe the requirements for the power range of the generator!

8.2.2. Pre-heating

The maximum bridgeable distance between the fusion coupler and the pipe must never exceed 3 mm around the entire circumference. This will mean $\Delta d \leq 6$ mm for the fusion coupler which is centred on the pipe. Pre-heating can be utilised in order to compensate for the annular gap between the coupler and pipe within certain limits. Thermal reduction of tensile stresses in the joint area will also have a positive effect on the fusion result.

i INFO

Utilising pre-heating technology is optional for the UB d 400 - d 450 and for UB PN25 d 280 - d 355 couplers when an annular gap > 1 mm is required. Utilising the pre-heating technology is mandatory for UB \geq d 500 couplers.

Procedure for utilising pre-heating technology:

1. Always prepare the connection area in accordance with these assembly instructions.
2. Centre the coupler on the pipe in such a way that the annular gap is as even as possible around the circumference. If necessary, support the coupler.
3. Seal the annular gap with adhesive tape in order to prevent any thermal loss.
4. Seal the open pipe ends in order to prevent a chimney effect.
5. Standard processing:
 - a. Pre-heat the **first** coupler side, read the yellow barcode with the fusion unit in order to commence the process, subsequently
 - b. pre-heat the **second** coupler side, read the yellow barcode with the fusion unit in order to commence the process, subsequently
 - c. first coupler side: Inspect the annular gap: When this is still too large, then pre-heating can be repeated for a maximum 2 more times. When OK: Start the fusion process for the **first** coupler side (read-in white barcode), subsequently
 - d. second coupler side: Inspect the annular gap: When this is still too large, then pre-heating can be repeated for a maximum 2 more times. When OK: Start the fusion process for the **second** coupler side (read-in white barcode).

i INFO

Maintain a pause between the pre-heating and the actual fusion process to allow the components (coupler and pipe) to heat up evenly. This pause corresponds approximately to the pre-heating or fusion time, depending on the dimension, i.e. approx. 15-30 minutes. The pause between pre-heating and fusion must be observed when only processing one side of the coupler. If the pause time is exceeded by more than double, then repeat the process described above.

8.2.3. Reading the barcode and start the fusion process

CAUTION

Plastic melt escaping during the fusing process

Burns on the skin

Always maintain a distance of one metre from the fusing site during the fusion process for general safety reasons.

i INFO

Always inspect and, if necessary, correct the proper alignment of the fusion joint before commencing the fusion process.



Image 21:

The fusion parameters are contained in the upper barcode, which is attached to the barcode sticker on the fusion fitting.

If you will be using fully automatic fusion units such as the FRIAMAT fusion units and similar fusion units, then the fusion parameters are to be read into the fusion unit using a reading wand or a hand-held scanner.

The lower barcode on the barcode sticker contains the data for the component traceability. It is only to be read in when the component traceability should be utilised.

i INFO

Suitable fusion units e.g. FRIAMAT fusion units and similar devices are required for the component traceability procedure.

i INFO

If required, the data can be entered manually into the FRIAMAT fusion unit by utilising the emergency input mode.



Image 22:

After the fusion barcode has been read in, which is confirmed with an acoustic signal tone, then the data on the display of the fusion unit must be compared with the data located on the fusion fitting.

If they match, then start the fusion process.

The fusion unit automatically monitors the fusing process and thereby regulates the introduced energy in specified limits.

The end of the fusion process will be signalled by two acoustic signals (with FRIAMAT fusion units).

I INFO

Always observe the operating instructions and the specifications of the fusion unit manufacturer.



Image 23:

Alternatively, the fusion process for the FRIAMAT 7 prime and FRIAMAT 6 prime eco fusion unit types can be conveniently started and controlled using the WorkFlow app.

The integrated barcode scanner means that fusion barcodes and traceability barcodes can be read out and all relevant data can be displayed easily and clearly.

Fusion protocols will be automatically transferred to the WorkFlow app and additional information such as geo data, photographs and comments can be added quickly and easily.

I INFO

The fusion indicator provides an indication of the fusion process which is being executed. However, the correct fusion process is only indicated by the fusion unit.

8.2.4. Designation marking of the fusion joint and decontacting the fusion unit



Image 24:

After fusing has been completed, the actual fusing time achieved must be compared with the target fusing time on the fusion unit and noted down on the pipe or the fusion fitting with a marker.

This marking procedure will also ensure that no fusion site is overlooked.

Once the fusion time has elapsed, the fusion cable can be removed from the fusion fitting.

8.2.5. Repeating the fusion process

If the fusion process is interrupted, then the fusion process can be repeated in case of doubt. The connection position or joint must, however, have cooled down to ambient temperature before fusion commences again.

i INFO

In the event of a repeated fusion process, please contact your specialist technical sales engineer or the Aliaxis Deutschland GmbH hotline, telephone number: +49 621 486-1486.

8.2.6. Cooling time

HINT

Premature movement of the fusion joint, i.e. before the cooling time CT has elapsed.

This will lead to leaking joints.

Always observe the cooling time CT which has been specified on the barcode!

Cooling time is defined as:

1. **Cooling time CT:** The time which the fusion jointing requires in order to cool down to the temperature at which the component and/or connection may be moved. This time is identified on the barcode sticker with CT (Cooling Time) and stated with the value in minutes.

2. **Cooling time for pressurising:** The time which the fusion joining requires in order to cool down to the temperature at which it is possible to pressurise with the full test pressure and/or working pressure without any damage caused to the fusion joint. A distinction will therefore be made between pressures up to 8 bar and > 8 bar.

Diameter [mm]	Cooling time [minutes] for FRIALEN Safety Fittings - Couplers and moulded parts		
	CT 110 until the connection may be moved	CT 70 until pressurised to 8 bar	until pressurised > 8 bar
20 – 32	5	8	10
40 – 63	7	15	25
75 – 110	10	30	40
125 – 140	15	35	45
160 – 225	20	60	75
250 – 355	30	75	100
400 – 800	40	95	120
900 – 1200	90	200	240

I INFO

A pressure test (see EN 805, EN 12007 or DVGW G 469, W 400) must always be initially executed before commissioning a pipe. Always observe the guidelines of the DVGW codes of Practice or applicable worksheets for pressure tests and/or European standards or the corresponding national regulations and guidelines.

I INFO

FRIALEN UB \geq d 315 (SDR 17) or \geq d 400 (SDR 11) couplers are fitted with an external reinforcement (wire winding) in order to ensure optimum joining pressure during the fusion process. The detachment of the external reinforcement from the coupler body during the cooling phase is caused by the thermal expansion behaviour of the fusion joint and is not deemed to create a negative aspect.

i INFO

The respective cooling times for FRIALEN saddle moulded parts e.g. DAV, DAA, SA, SPA, etc. can be found in the corresponding product-related chapter in these assembly instructions.

9. FRIASTOP Gas-Stop Unit

9.1. About the product



Image 25:

Gas-stop units are preferably installed as a safety unit in the branch from the main pipe to the domestic service line directly after the pressure tapping tee. The required type will be selected according to the minimum working pressure of the network and the consumer-dependent, required flow rate.

The gas-stop unit which has been laid for underground external pipes closes automatically at a defined gas flow rate, as typically occurs when the gas domestic service line is damaged. The gas flow is always interrupted immediately and abruptly. The pressure in the remaining, intact gas pipe length can rise again as a result of the overflow volume, so that the gas stop opens again automatically.

i INFO

Installing the FRIASTOP gas-stop unit will be executed for gas service pipes in accordance with DVGW Code of Practice G 459-1:2019-10 - Gas service connections for maximum working pressure up to and including 5 bar.

9.2. Product description

9.2.1. FRIASTOP M Gas-Stop Unit



Image 26:

▪ SENTRI GS Gas-Stop Unit Maxitrol System

Will be utilised in gas service lines with a working pressure from 25 mbar* to 5 bar*. It is a safety unit which will automatically shut-off the gas flow in the event of pipe damage e.g. caused by excavation action or drilling work.

* Working pressure range	Type
25 mbar - 1 bar	D ¹
35 mbar - 5 bar	Z ¹
100 mbar - 5 bar	B ²

¹ With overflow device

² Without overflow device

9.2.2. FRIASTOP P Gas-Stop Unit



Image 27:

▪ Gas Stop Gas-Stop Unit Pipelife System

Will be utilised in gas service lines with a working pressure from 25 mbar* to 5 bar*. It is a safety unit which will automatically shut-off the gas flow in the event of pipe damage e.g. caused by excavation action or drilling work.

* Working pressure range	Type
25 mbar - 1 bar	A ¹ /D ¹
35 mbar - 5 bar	U ² /U _{UE} ¹
200 mbar - 5 bar	S ¹ /S _{OU} ²

¹ With overflow device

² Without overflow device

9.3. Preparatory work and installation



The FRIALEN FRIASTOP P and FRIASTOP M gas-stop units are to be processed like an electrofusion coupler (remove the oxide layer, cleaning the fusion zone, assembly etc.) refer to Chapter 7. Processing the FRIALEN safety fittings, P.18 and 8. Assembly and processing: Couplers and moulded parts, P.26.

Image 28:

i INFO

Always observe the rating plate of the manufacturer of the gas-stop unit on the FRIALEN safety fitting when installing it;

- Throughflow direction according to the marking on the component
- Type designation
- Functional pressure range
- Maximum nominal flow rate / Maximum pressure loss

i INFO

Always ensure that there are no impurities such as swarf, leaves etc. present in the pipes during installation. This would impair the function of the gas-stop unit.

9.4. Commissioning

Commissioning by tapping or drilling on the main pipe and/or filling the domestic service line must always be executed with a slow increase in pressure in order to prevent the gas-stop unit from closing.

Closed gas-stop units can be reopened by applying counter-pressure (up to mains pressure) when using a suitable pressure source, e.g. nitrogen or natural gas cylinder.

The test air must be fed upstream of the gas flow switch during the pressure test in such a way that the closing flow rate at the gas-stop unit is not reached.

If the gas-stop unit closes, then the next downstream section will not be tested.

If the pressure downstream of the gas-stop unit has to be depressurised e.g. during venting, then this must be executed in a controlled manner. If the pressure is released too quickly or the valve opening is too large, then the gas-stop unit can close.

10. Ball valves

10.1. About the product



Image 29:

The FRIALEN ball valves **KH** and **KHP** with an NBR gasket are utilised as shut-off valves in pipes for gas and water supplies (no potable water!) as well as in compressed air pipes.

The FRIALEN ball valve **KHW** with an EPDM gasket and with potable water approval will be utilised as a shut-off valve in water supply pipes as well as in pipes for mineral water and sea water.

i INFO

The ball valve must be actuated at least once a year in order to ensure that the ball valve functions faultlessly!

i INFO

Processing the tapping ball valves for lateral tapping and drilling with the AKHP and AKHP TL will be described in the corresponding chapters for the saddle components which are processable with an under clamp and/or saddle components which are processable with the FRIATOP clamping unit.

10.2. Product description

10.2.1. Ball valve for gas



Image 30:

- **KH / KHP:**

Application for gas and H₂, maximum permissible working pressure 10 bar.
NBR sealing material

10.2.2. Ball valve for water



Image 31:

- **KHW:**

Application for water, maximum permissible working pressure 16 bar.
EPDM sealing material

10.3. Preparatory work and installation



Image 32:

The FRIALEN KH, KHP and KHW ball valves will be connected on a PE pipe at the PE fusion ends with a coupler, elbow or T-piece using electrofusion.

The PE fusion ends of the ball valve are to be prepared for electrofusion in accordance with the general assembly and installation requirements (remove/clean oxide layer).

Refer to Chapter 7. [Processing the FRIALEN safety fittings, P.18](#)

i INFO

The ball valve must always be aligned according to the intended actuation in order to ensure that the actuating linkage is seated correctly before the fusion process commences.

i INFO

The media identification and the closing direction can be marked in the street cap by utilising a marking disc (included in the scope of delivery).

10.4. Commissioning



Image 33:

The KBS telescopic actuating linkage for operating the ball valve from the street cap is optimally matched to the ball valve.

Opening and closing the ball valve will be executed with a 1/4 turn of the actuating element.

11. FRIALOC PE Shut-Off Valve

11.1. About the product



Image 34:

The FRIALOC will be utilised as a PE shut-off valve in PE pipe systems for water distribution in accordance with DVGW W400-2 and DIN EN 805 with a maximum operating pressure of 16 bar. The PE shut-off valve's pipe-like through passage will not create any constrictions compared to the SDR 11 connection pipe.

Actuating it will be executed from the street cap by using the appropriate FBS actuating linkage.

i INFO

The FRIALOC is considered to be maintenance-free and can be installed and operated directly in the ground without a manhole.

11.2. Product description



Image 35:

▪ FRIALOC:

Application for water, maximum permissible working pressure 16 bar.

Integration is preferably executed homogeneously in PE pipes with an electrofusion coupler or overarching materials using mechanical jointing technology.



Image 36:

The FRIALOC two-flap system always adapts flexibly to the operating conditions and thereby ensures reliable shut-off.

The minimal surface area provided by the seal reduces biological growth.

11.3. Preparatory work and installation

The FRIALOC PE shut-off valve will be connected to a PE pipe at the PE fusion ends with a coupler by utilising electrofusion. The FRIALOC PE fusion ends are to be prepared for electrofusion in accordance with the general assembly and installation requirements (remove/clean oxide layer). Refer to Chapter 7. [Processing the FRIALEN safety fittings, P.18](#) and 8. [Assembly and processing: Couplers and moulded parts, P.26](#)

The FRIALOC PE fusion ends are equipped with double fusion lengths and fulfil the geometric requirements for PE pipes in accordance with DIN EN 12201-2 in the connection area.

The protective caps located on the PE fusion ends should only be removed from the fusion ends immediately before installation in order to prevent soiling or contamination.



Image 37:

When assembling the FRIALOC in pipes which are made of other materials such as PE, then the connection must always be created by using mechanical jointing technology e.g. a FRIAGRIP coupling.

i INFO

Internal support sleeves may only be inserted up to the end of the FRIALOC pipe spigot in order to prevent them from blocking the installed butterfly valves and/or shut-off flaps.

i INFO

Always observe the assembly instructions and the manufacturer's installation notes for the respective mechanical jointing technology. For products from Aliaxis Deutschland GmbH, refer to the Homepage <http://www.aliaxis.de/de/downloads>

A base plate can be utilised in order to increase the footprint of the FRIALOC PE shut-off valve in the trench bottom. The PE base plate is to be assembled and secured to the four feet of the FRIALOC PE shut-off valve by utilising suitable screws or bolts depending on the substrate.

The FRIALOC must never be designed or created as a fixed point for the pipe to absorb forces, such as flow momentum which can be caused by a change in direction of the flowing medium or by thermal length alterations in the pipes.

The FRIALOC must be adequately covered over before working with standard soil compaction equipment.

11.4. Commissioning



Image 38:



Image 39:

The FBS telescopic actuating linkage and the FRIALOC are ideally matched to each other.

The KlickFix coupling coupler located on the FBS actuating linkage is to be pushed (without tools) over the actuating square unit of the FRIALOC. The KlickFix coupling coupler will therefore engage in the recesses of the actuating square unit located on the dome of the FRIALOC and therefore creates a tension-proof connection.



Image 40:

The FBS telescopic operating linkage for operating the FRIALOC enables the desired cover height to be freely adjusted at all times without tools (self-supporting in any extension position). Overloading the fitting drive unit due to over-tightening is ruled out with the FBS actuating linkage.

The sleeve tube bell will be pushed over the dome of the FRIALOC. Hooks on the sleeve tube will therefore engage in recesses on the dome and create a stable and dirt-tight connection. This connection can be released again by turning the sleeve tube anti-clockwise.



Image 41:

The FRIALOC PE shut-off valve is provided with an identification disc be assembled on the actuating linkage in the street cap and which therefore provides information relating to the direction of rotation and the number of turns required to open and close the fitting.

Closing the FRIALOC PE shut-off valve will be executed in a clockwise direction (**closing to the right**). Utilising the FRIALOC ACW (anti-clockwise) will execute the closing as anti-clockwise (**closing to the left**).

8 INFO

The FRIALOC PE shut-off valve is closed in its as-delivered condition.

The "Open" and "Closed" end-stop positions of the FRIALOC PE shut-off valve are clearly signalled to the user by metal end stops.

i INFO

Testing / pressure test

The pressure test of the pipes is always to be executed in accordance with W400-2 and may only be performed when the FRIALOC is fully open.

i INFO

Flushing

Flushing the pipe will be executed in accordance with W400-2 when the FRIALOC is open.

i INFO

Servicing and maintenance

FRIALOC PE shut-off valves are maintenance-free. The inspection and servicing intervals in accordance with DVGW W392 must be complied with.

12. Processing saddle components with under clamp

12.1. About the product



Image 42:

The FRIALEN saddle moulded parts with under clamp will be assembled on the PE pipe using an under clamp. The under clamp is an integral part of the saddle component and is utilised for applying the joint pressure.

Clamping and fusing can be executed not only on pressure-free PE pipe but also on PE pipe which is subjected to working pressure.

The following saddle moulded parts will be assembled with the under clamp.

- **DAP** Pressure Tapping Tees with parallel dome
- **AKHP** Tapping ball valve for side tapping gas under pressure
- **SA** Saddle with spigot (refer to Fig.)
- **SAFL** Saddle with flange
- **RS** Repair Saddle (refer to Chapter [18. Repair and reinforcing saddles, P.129](#))
- **RSV** Repair and Reinforcing Saddles (refer to Chapter [18. Repair and reinforcing saddles, P.129](#))
- **SPA** Balloon Shut-off Saddles
- **VAM RG** Valve tapping saddle with HD-PE/gunmetal adapter

12.2. Preparatory work, assembly and installation

The FRIALEN saddle components with under clamp will be assembled on the PE pipe by utilising an under clamp.

The assembly area on the PE pipe must always be correctly prepared for electrofusion in accordance with the general assembly and installation requirements (mark and clean the fusion zone, remove the oxide layer etc.). Refer to Chapter [7. Processing the FRIALEN safety fittings, P.18](#)

- Loosen the pre-assembled bolts on the side.
- Fold open the upper part and lower part; the side that is still screwed in serves as a hinge.
- Place it on the processed, scraped pipe surface.

- Tighten in all four screwed connections evenly crosswise with a hexagon socket spanner as far as they will go.
- Spanner width for the internal hexagon bolts SW 5 to d 75 and SW 6 to d 90.

i INFO

Under clamps are an integral part of the FRIALEN saddle components with under clamp and are utilised to apply the joint pressure.

- Start the fusion process after assembly is completed.

12.3. Commissioning

After the fusion has been completed and the cooling time has expired, then the pressure test can be executed and the saddle component can be commissioned.

12.3.1. Commissioning the DAP pressure tapping tee with parallel dome

Execute the domestic service line installation. Always hereby observe the general assembly requirements for electrofusion (remove oxide layers/cleaning). Refer to Chapter 7. [Processing the FRIALEN safety fittings, P.18](#) and 8. [Assembly and processing: Couplers and moulded parts, P.26](#)



Image 43:

A sealing test is always recommended before drilling or tapping. Always utilise the FRIATOOLS FWDPA pressure test adapter for this task.

Tapping will be executed with the FWSS SW 17 activating key for $d_1 \leq 63$ and/or FWSS SW 19 for $d_1 \geq 90$.

Remove the sealing plug.
Tapping will be executed as clockwise until the bottom end stop is reached. The pressure tapping tee is now closed. To open it, the drill must be turned anti-clockwise back to the upper end stop. Then screw the sealing plug back into the tapping stack until the collar of the plug lightly touches the tapping stack. Never screw it in with force!

We recommend closing the dome with the FRIALEN DK closing cap as permanent access protection for the dome.

i INFO

If there is an application intended using hydrogen H₂, then the DK closing cap must always be utilised for access protection.

12.3.2. Commissioning the AKHP tapping ball valve for side tapping gas under pressure



Image 44:

The FRIALEN AKHP ball valve will be connected on a PE pipe at the PE fusion ends with a coupler, elbow or T-piece by utilising electrofusion. The PE fusing ends of the ball valve are to be prepared for electrofusion in accordance with the general assembly and installation requirements (remove oxide layer/cleaning). Refer to [Chapter 7. Processing the FRIALEN safety fittings, P.18](#) and [8. Assembly and processing: Couplers and moulded parts, P.26](#)

The KBS telescopic actuating linkage for operating the ball valve from the street cap has been optimally matched to the ball valve. Opening and closing the ball valve will be executed with a 1/4 turn of the actuating element.

i INFO

The ball valve must be actuated at least once a year in order to ensure that the ball valve functions faultlessly!

12.3.3. Commissioning the SA saddle with spigot



Image 45:

Pipe branches or vents can be easily created with the FRIALEN SA saddle with spigot. This replaces the cost-intensive integration of T-pieces. FRIALEN couplers or fittings fit onto the SA outlet spigots.



Image 46:

Tapping will be executed in a depressurised condition with a commercially available hole saw.

If it necessary to tap under working pressure, then we recommend the tapping equipment from Hütz und Baumgarten.

Please contact the hotline from Aliaxis Deutschland GmbH, telephone number: +49 621 486-1486 for tapping under working pressure.

For commissioning, implement the domestic service line installation. Always hereby observe the general assembly requirements for electrofusion units (remove oxide layers/cleaning). Refer to Chapter 7. [Processing the FRIALEN safety fittings, P.18](#) and 8. [Assembly and processing: Couplers and moulded parts, P.26](#)

12.3.4. Commissioning the saddle with SAFL flange



SAFL spigot saddle for integrating hydrants and fittings. The saddle of the spigot saddle with SAFL flange outlet will be assembled and fused onto the main pipe. The main pipe can be tapped in a depressurised condition or when it is subjected to working pressure after fitting a gate valve on the flange side. We recommend the Hütz und Baumgarten tapping equipment for tapping under working pressure. The flange connection dimensions comply with DIN EN 1092-1.

Image 47:

i INFO

Additional washers are required. All commercially available profile seals and flat gaskets can be utilised. We recommend profile seals of type G-St. Always observe the screw tightening torques from the specification from the gasket or seal manufacturer.

Please contact the hotline from Aliaxis Deutschland GmbH, telephone number: +49 621 486-1486 when required.

12.3.5. Commissioning the SPA balloon shut-off saddle



Image 48:

The FRIALEN SPA balloon shut-off saddle will be utilised to shut-off the flow of media through commercially available balloon setting devices or to vent and/or flush the PE pipe.

Inserting the brass plug: The plug must be screwed in until the O-ring in the dome of the SPA balloon shut-off saddle seals correctly. The plug will protrude beyond the dome sleeve by approx. 1.5 mm in the end-stop position. The brass plug must always be screwed in all the way until a metallic end stop can be felt.



Image 49:

After assembling the brass plug, either the supplied plastic screw cap can be screwed on as access protection for the dome, or the FRIALEN SPAK closing cap can be fused on as permanent access protection.

i INFO

If there is an application intended using hydrogen H_2 , then the SPAK closing cap must always be utilised for access protection.

12.3.6. Commissioning the valve tapping saddle with HD-PE/gunmetal adapter VAM RG



The VAM RG valve tapping saddle is utilised for mounting commercially available brass valves. It will be tapped in according to the respective assembly and installation instructions of the various valve manufacturers using an appropriate airlock unit and/or mounted with a valve. A pressure test will be prepared and executed in accordance with the valve manufacturer's instructions.

Image 50:

i INFO

The factory-fitted metal threaded parts must always be secured against twisting with a spanner during the valve assembly work.

i INFO

Always ensure that the insulation work is executed out in accordance with DVGW regulations.

13. Processing saddle components for top-loading

13.1. About the product



Image 51:

The FRIALEN top-loading saddle moulded parts will be assembled on the PE pipe using the FRIATOP clamping unit.

The FRIATOP clamping unit can be utilised for all pipe diameters in the specified size range and always therefore ensures optimum joint pressure build-up during fusion. The following top-loading saddle moulded parts and fittings will be assembled by utilising the FRIATOP clamping unit.

- **DAV TL** Top-Loading Pressure Tapping Valves (refer to Chapter [14.4. Top-Loading DAV TL Pressure Tapping Valves, P.84](#))
- **DAA TL** Top-Loading Pressure Tapping Tees (refer to Chapter [14.2. Top-Loading DAA TL Pressure Tapping Tees, P.71](#))
- **AKHP TL** Tapping ball valve for side tapping gas under pressure
- **SA TL** Top-Loading Saddle with Spigot (refer to Chapter [15. Saddle with spigot, top-loading, P.88](#))
- **RS TL** Top-Loading Repair Saddle (refer to Chapter [18. Repair and reinforcing saddles, P.129](#))
- **SPA TL** Top-Loading Balloon Shut-off Saddle
- **VAM RG TL** Valve tapping saddle top-loading with HD-PE/gunmetal adapter (refer top Fig.)

13.2. Preparatory work, assembly and installation

The FRIALEN top-loading saddle components will be assembled on the PE pipe using the FRIATOP clamping unit. Always observe the FRIATOP clamping unit operating instructions for the assembly and operation of the clamping unit, which are available on the Aliaxis Homepage <https://www.aliaxis.de/de/downloads>

The assembly area on the PE pipe must always be correctly prepared for electrofusion in accordance with the general assembly and installation requirements (mark and clean the fusion zone, remove the oxide layer etc.). Refer to Chapter 7. [Processing the FRIALEN safety fittings, P.18](#)

- Place the adapter which is suitable for the top-loading saddle component onto the saddle.
- Always observe the FRIATOP clamping unit operating instructions when selecting the adapter and assembling the housing.
- Place the housing of the FRIATOP clamping unit on the adapter and the top-loading saddle component.
- Place the tensioning belt around the pipe and thread it into the pull-up rollers on the star knob.
- Turning the star knob will tighten the belt and pre-assemble the clamping unit.
- Connect a compressed air pump to the connector located on the housing.
- The housing will be pushed apart and the top-loading saddle component is then clamped onto the pipe without a gap by pumping with the compressed air pump.
- Unlock the clamping lever on the air hose and pull the air hose off the valve.
- Inspect again whether the top-loading saddle component is positioned correctly on the pipe without any gaps and then execute the fusing process.
- Any pressure loss occurring in the system during the fusion process must be controlled in the housing window on the FRIATOP clamping unit using the clamping number displayed.

13.3. Commissioning

After the fusing process has been completed, then it is essential to observe the cooling time until the saddle component can be commissioned.

I INFO

Always comply with the required clamping time after the fusing process until dismantling the FRIATOP clamping unit.

13.3.1. Commissioning the AKHP TL tapping ball valve Top-Loading for side tapping gas under pressure

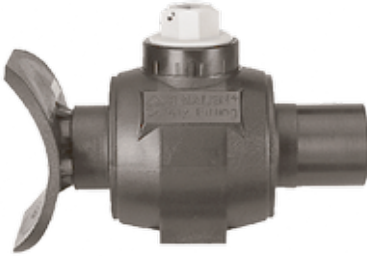

Image 52:

The FRIALEN AKHP TL tapping ball valve Top-Loading will be connected on a PE pipe at the PE fusion ends with a coupler, bend or T-piece by utilising electrofusion.

The PE fusing ends of the ball valve are to be prepared for electrofusion in accordance with the general assembly and installation requirements (remove oxide layer/cleaning). Refer to Chapter [7. Processing the FRIALEN safety fittings, P.18](#) and [8. Assembly and processing: Couplers and moulded parts, P.26](#)

The KBS telescopic actuating linkage for operating the ball valve from the street cap has been optimally matched to the ball valve. Opening and closing the ball valve will be executed with a 1/4 turn of the actuating element.

i INFO

The ball valve must be actuated at least once a year in order to ensure that the ball valve functions faultlessly!

13.3.2. Commissioning the SPA TL top-loading balloon shut-off saddle



Image 53:

The FRIALEN SPA TL top-loading balloon shut-off saddle will be utilised to shut-off the flow of media through commercially available balloon setting devices or to vent or flush the PE pipe. Inserting the brass plug: The plug must be screwed in until the O-ring in the dome of the SPA TL balloon shut-off saddle seals correctly. The plug will protrude beyond the dome sleeve by approx. 1.5 mm in the end-stop position. The brass plug must always be screwed in all the way until a metallic end stop can be felt.

i INFO

The fusion range of the FRIALEN SPA TL balloon shut-off saddle covers the dimensions d 250 - d 560. If necessary, application-related restrictions must be taken into account, e.g. due to the drill tool or balloon shut-off which is utilised.

Always observe the manufacturer's instructions for these components!
Processing temperature: 0 °C to 45 °C.



Image 54:

After assembling the brass plug, either the supplied plastic screw cap can be screwed on as access protection for the dome, or the FRIALEN SPAK closing cap can be fused on as permanent access protection.

i INFO

If there is an application intended using hydrogen H_2 , then the SPAK closing cap must always be utilised for access protection.

13.3.3. Commissioning the valve tapping saddle top-loading with HD-PE/gunmetal adapter VAM RG TL



Image 55:

The VAM RG TL valve tapping saddle top-loading is utilised for mounting commercially available brass valves. It will be drilled according to the respective assembly and installation instructions of the various valve manufacturers using an appropriate airlock unit and/or mounted with a valve. A pressure test will be prepared and executed in accordance with the valve manufacturer's instructions.

i INFO

The fusion range for the VAM RG TL valve tapping saddle top-loading comprises the dimensions d 250 - d 560. Any technical application restrictions due to drilling tools may need to be taken into account. Always observe the manufacturer's instructions for these components!

i INFO

The factory-fitted metal threaded parts must always be secured against twisting with a spanner during the valve assembly work.

i INFO

Always ensure that the insulation work is executed out in accordance with DVGW regulations.

14. Pressure tapping tees and pressure tapping valves

14.1. DAA RED SNAP Pressure Tapping Tees

14.1.1. About the product



The FRIALEN DAA RED SNAP pressure tapping tees are utilised as a branch fitting in unpressurised, or PE pipes which are subjected to working pressure, for applications for gas, water and H₂ pipes.

Assembling the pressure tapping tees will be executed on the HD-PE pipe by utilising the innovative and patented RED SNAP fast-clamping lever.

Image 56:

14.1.2. Product description



Image 57:

- **DAA RED SNAP:**

Processing range (maximum permissible working pressure):

Water 16 bar / gas 10 bar

Processing-capable on PE pipes with SDR range 11 to 17.6 in a dimension range from d_1 40 to d_1 225.

Always observe the SDR details provided on the barcode.

14.1.3. Preparatory work and installation

The DAA RED SNAP pressure tapping tees will be assembled on the PE pipe without any additional tools by using the patented RED SNAP fast-clamping lever.

The assembly area on the PE pipe must always be correctly prepared for electrofusion in accordance with the general assembly and installation requirements (mark and clean the fusion zone, remove the oxide layer etc.). Refer to Chapter 7. [Processing the FRIALEN safety fittings, P.18](#)



Image 58:

Position the DAA RED SNAP pressure tapping tee on the processed, scraped pipe surface and then guide the under clamp around the pipe.



Image 59:

Insert the clamping surface of the RED SNAP fast-clamping lever into the clamping strip of the upper saddle part. Always ensure that the clamping strip is correctly positioned in the saddle mounting area.



Image 60:

Actuating the fast-clamping lever upwards will clamp and tension the DAA RED SNAP pressure tapping tee firmly onto the pipe.

i INFO

The elastic design which is incorporated into the clamping mechanism (fast-clamping lever) of the DAA RED SNAP pressure tapping tees can also cover large pipe tolerances and therefore always ensures an optimum and even build-up of fusion pressure during the fusion process. Always therefore prevent unnecessary clamping operations before fusion, especially when the pipe is already expanded. The clamping force can otherwise be reduced and can therefore create a negative effect on the fusion result. Releasing the clamping to align the fitting correctly on the pipe is of course permissible.

i INFO

The factory drill setting must never be altered before the fusion process is commenced for pressure tapping tees.

14.1.3.1. Assembly in confined spaces

The DAA RED SNAP pressure tapping tees can also be assembled in areas where the space is limited e.g. in parallel pipelines. It must always be ensured in such cases that the minimum distance between the pipes, which is required for the assembly work, is not less than 30 mm.



Image 61:

Pre-position the pressure tapping tee on the prepared pipe surface. The DAA RED SNAP pressure tapping tee can be pre-positioned in any position on the pipe circumference.



Image 62:

Insert the fast-clamping lever into the clamping strip of the upper saddle part.



The DAA RED SNAP pressure tapping tee is now pre-tensioned on the pipe, although it can still be moved.

Image 63:



Position the DAA RED SNAP pressure tapping tee in the desired end position on the pipe. Subsequently clamp the DAA RED SNAP pressure tapping tee firmly onto the pipe by pressing the fast-clamping lever upwards.

Image 64:

14.1.4. Fusion

Always observe the working steps for executing the fusion process (contacting the fusion unit, reading in the barcode and starting the fusion process, marking of the fusion joint etc.). Refer to Chapter [8.2. Fusion process, P.27](#)

The following working pressures must not be exceeded during the fusion process and until complete cooling has been achieved when implementing a fusion process on the DAA RED SNAP pressure tapping tees on pipes which are carrying media:

Pipe material	PE 80		PE 100	
	SDR range	17	11	17
Maximum permissible working pressure (bar)				

Gas	2	5	5	10
Water	8	12.5	10	16

The following cooling times (CT) must be adhered to after the fusion process.

Diameter (d ₁ main pipe) in mm	Cooling time (CT) in minutes
40	5
50	7
63	10
75	13
90	13
110	16
125 - 140	18
160 - 225	28

i INFO

The cooling time (CT), which has been specified on the barcode sticker of the DAA RED SNAP pressure tapping tees always corresponds to the cooling time up to pressurisation via outlet as well as the cooling time up to tapping.

i INFO

If these waiting times are not observed, there will be a risk of leaks from the fusion joint. The general installation instructions must be observed before tapping.

14.1.5. Tapping and commissioning

i INFO

Before tapping the main pipe, make sure that the service line has been connected and its end point is sealed. This will prevent uncontrolled discharges of media.

The service line may be pressure tested before the main pipe is tapped.

14.1.5.1. Installing the domestic service line



Image 65:

Always implement the installation of the domestic service line by observing the general assembly and installation requirements for electrofusion (remove/clean oxide layer). Refer to Chapter [7. Processing the FRIALEN safety fittings, P.18](#) and [8. Assembly and processing: Couplers and moulded parts, P.26](#)

i INFO

A gas-stop unit must be installed for gas service lines in accordance with DVGW Code of Practice G459-1. This gas-stop unit is a safety unit which will automatically shut-off the gas flow in the event of pipe damage, e.g. caused by excavation action or drilling work. Please observe to processing instructions for the gas-stop unit Chapter [9. FRIASTOP Gas-Stop Unit, P.34](#)

14.1.5.2. Pressure test

The domestic service line must always be pressure tested in accordance with DVGW Code of Practice G469 (for gas applications) and W400 (for water applications).

The pressure test on the domestic service line can be executed from the house side or a pressure test can be executed via the dome located on the DAA RED SNAP pressure tapping tee by utilising the FRIATOOLS FWDPA pressure test adapter.

i INFO

The pressure test may only be executed after the cooling time (CT) has elapsed!

The pressure test with the FRIATOOLS FWDPA pressure test adapter when utilising the dome of the DAA RED SNAP pressure tapping tee is described below.

i INFO

Drilling the punch drill in and the assembly or installation of the FWDPA pressure test adapter must never be executed with the DAA RED SNAP unit assembled or in a fused-on condition, rather only in a workshop which is equipped with suitable mounting, tensioning and clamping facilities. The fusion coil which is located on the saddle surface of the DAA RED SNAP must never be damaged or soiled in the process. The factory-created position of the DAA RED SNAP punching drill must never be altered because this will otherwise make subsequent assembly, installation and fusion onto the main pipe impossible.

i INFO

Always control the O-ring located on the screw-in thread before using the FWDPA pressure test adapter. If the O-ring is found to be defective or porous, then it must always be exchanged.

The FRIATOOLS FWDPA pressure test adapter is utilised exclusively for tapping the punch drill of the FRIALEN DAA RED SNAP pressure tapping tees and for mounting the pressure testing unit for pressure testing via the dome located on the DAA RED SNAP. This user-side tapping therefore enables pressure testing of a fused-on DAA RED SNAP including the domestic service line directly via the dome.

The FWDPA pressure test adapter thereby provides:

- A drill sleeve as a guide for centred drilling of the punch drill
- The connection for a pressure testing unit.

The following are also required and must be provided by the user:

- A commercially available drill with HSS twist drill bit, d 8 mm and a length of at least 100 mm
- A suitable pressure testing unit.

Preparatory work in the workshop:



Image 66:

Remove the DAA RED SNAP from the foil pouch and retain this object for repacking.
Remove the sealing plug from the DAA RED SNAP by unscrewing it in an anti-clockwise direction and store it in a place which is protected against soiling or contamination.

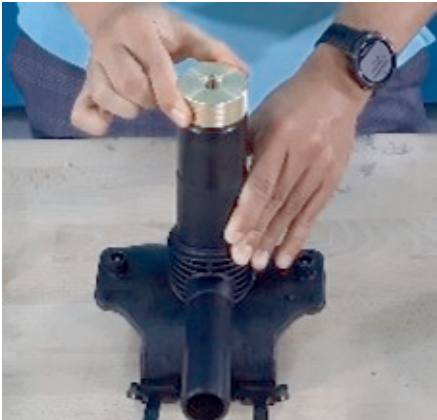

Image 67:

Screw the FWDPA pressure test adapter in a clockwise direction manually into the dome of the DAA RED SNAP until it reaches the end stop tightly.



Image 68:

Position the DAA RED SNAP stably on a suitable work surface. Inspect that the drill is set up correctly (medium revolution speed, without impact mechanism).

Drill the punch drill bit of the DAA RED SNAP with a drill via the drill sleeve of the FWDPa at medium revolution speed and without impact mechanism. The punch drill bit must always be drilled all the way through.

i INFO

Only utilise a HSS twist drill bit, with d 8 mm and a length of 100 mm. Always observe the specifications and guidelines of the manufacturer of the drill which is to be utilised.

Remove the FWDPa pressure test adapter by unscrewing it in an anti-clockwise direction. Control the patency of the drill hole. Remove any metal drilling chips from above and below the hole by tapping them out by manually when necessary. Screw the DAA RED SNAP pressure test adapter in a clockwise direction manually into the dome of the DAA RED SNAP again until it reaches the end stop tightly.

After assembling and fusion for the DAA RED SNAP pressure tapping tees on the construction site:

i INFO

Never drill into the main pipe before the pressure test has been executed by utilising the dome. Otherwise the pressure test can no longer be executed separately from the main pipe!



Image 69:

Always observe the relevant national regulations and guidelines (e.g. DVGW worksheet G469 or W400) when executing the pressure test. The test connection must always be provided by the user. Always observe the manufacturer's operating instructions for the test connection. Connect the test connection to the FWDPA pressure test adapter.



Image 70:

Remove the sealing plug on the DAA RED SNAP by unscrewing it in an anti-clockwise direction and store it in a place which is protected against soiling or contamination. Screw the FWDPA pressure test adapter with the test connector in a clockwise direction manually into the dome of the DAA RED SNAP until it reaches the end stop tightly.

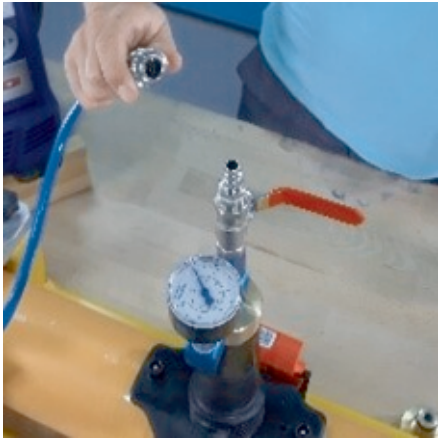

Connect the pipe with the test medium to the test connection. Fill the pipe up slowly, prevent any pressure surges and, if necessary, always observe the specifications when utilising a gas-stop unit.

Image 71:

Execute the pressure test in accordance with the applicable national regulations.

Remove the pipe initially from the test connection after the pressure test has been successfully completed. The domestic service line for the utility must then be carefully and completely vented via the test connection. Subsequently remove the FWDPA pressure test adapter with test connection from the dome of the DAA RED SNAP by unscrewing it in an anti-clockwise direction.

14.1.5.3. Tapping

i INFO

The main pipe can be tapped after the cooling time (CT) has elapsed and a pressure test has been executed if applicable.



Remove the sealing plug located on the dome of the DAA RED SNAP pressure tapping tee.

Image 72:



Image 73:

Rotate the drill bit clockwise evenly down to the lower end-stop position by utilising the appropriate hexagon socket spanner FWSS 17 (spanner size 17).

Tapping the pipe has now been successful.

Now rotate the drill bit back anti-clockwise to the upper end-stop position.



Image 74:

The FWSS 17 hexagon socket spanner is provided with three drill holes in which the toggle can be positioned. The drill hole to be utilised will always depend on the dimension of the main pipe d_1 (refer to the table below).

The dimension ranges for the main pipe to tapped are engraved on the FWSS 17 hexagon socket spanner.

If the correct drill hole is utilised, then the toggle will be positioned directly above the tapping stack of the DAA RED SNAP after successful tapping.

Position for drilling	Main pipe dimension d_1
1	d 180 – d 225
2	d 63/63 and d 90 – d 160
3	d 40 – d 75 (exception d 63/63)

i INFO

Only utilise the FWSS 17 hexagon socket spanner for tapping the DAA RED SNAP pressure tapping tees!

Always ensure that the FWSS 17 hexagon socket spanner is in perfect condition before using it. There must never be any deformations or burrs present on the tool.

Never utilise a **wireless battery-powered screwdriver** for tapping work because overtightening the drill bit can result in damage on the component!

After the tapping process has been successfully concluded, fit the sealing plug and carefully screw it in hand-tight until the coupler of the plug lightly touches the face of the tapping stack.

i INFO

If the tightening force of the coupler is too high, then the plug can break and/or the hexagon socket could be overtightened. The plug must be exchanged in this case.

In addition to the FWSS 17 hexagon socket spanner, the telescopic 1/2" inch ratchet with the SW 17 FWSR-T socket spanner can be utilised for convenient tapping, especially for large dimensions for main pipes and/or when working on pipes at low ambient temperatures.



Tapping the DAA RED SNAP pressure tapping tees with the telescopic ratchet is normally executed in the same way as tapping with just the FWSS 17 hexagon socket spanner.

Image 75:

i INFO

Particular care must always be taken to prevent overtightening the drill bit at the lower end-stop position due to the high leverage occurring when tapping the DAA RED SNAP pressure tapping tees with a telescopic ratchet.

14.1.5.4. Access protection for the tapping dome



It is recommended that the tapping dome is always sealed off with a DK closing cap as access protection. The DK closing cap must always be correctly prepared for electrofusion in accordance with the general assembly and installation requirements (mark and clean the fusion zone, remove the oxide layer etc.). Refer to [Chapter 7. Processing the FRIALEN safety fittings, P.18](#)

Image 76:

i INFO

If hydrogen (H₂) will be utilised in the pipe, then the DAA RED SNAP pressure tapping tees must always be installed with a DK closing cap.

14.2. Top-Loading DAA TL Pressure Tapping Tees

14.2.1. About the product



Image 77:

The FRIALEN Top-Loading DAA TL Pressure Tapping Tees are utilised as a branch fitting in unpressurised or pressurised PE pipes for variable adaptation to all pipe diameters in the specified range.

Assembling the FRIALEN Top-Loading DAA TL Pressure Tapping Tees on the HD-PE distribution pipe will be executed by utilising the FRIATOOLS FRIATOP clamping unit (please refer to the FRIATOOLS operating instructions for the "FRIATOP clamping unit" for additional processing information on the Aliaxis Homepage <https://www.aliaxis.de/de/downloads>).

14.2.2. Product description

- DAA TL

Processing range (maximum permissible working pressure): Water 16 bar / Gas 10 bar
Processing-capable on PE pipes with SDR range 11 to 17,6 with a FRIATOP clamping unit, cross-dimensional processing from d 250 to d 400 (d 250 - d 315: SDR 11 and 17,6 and d 355 - d 400: SDR 17,6).

14.2.3. Processing

The Top-Loading DAA TL Pressure Tapping Tees will be assembled on the PE pipe by using the FRIATOP clamping unit.
The assembly area on the PE pipe must always be correctly prepared for electrofusion in accordance with the general assembly and installation requirements (mark and clean the fusion zone, remove the oxide layer etc.). Refer to Chapter 7. [Processing the FRIALEN safety fittings, P.18](#)

i INFO

FRIALEN Top-Loading DAA TL \geq d 355 pressure tapping tees can only be processed with SDR 17 and SDR 17.6 pipes for technical reasons. Processing temperature: 0 °C to 45 °C.

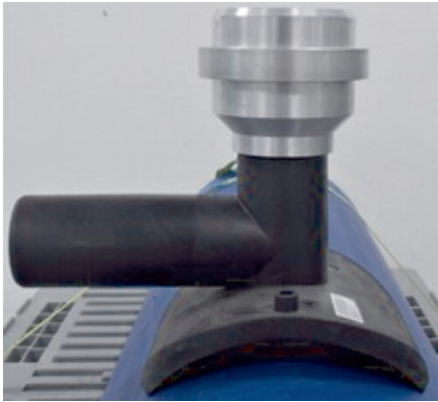

Image 78:

Position the Top-Loading DAA TL pressure tapping tee on the pipe surface which is to be processed. Place the adapter, which has been deemed to be suitable for the component to be processed, on the dome of the DAA TL.



Image 79:

Place the housing of the FRIATOP clamping unit on the adapter and the dome of the Top-Loading DAA TL pressure tapping tee. Guide the FRIATOP clamping unit tensioning belt around the pipe. Turning the star knob on the housing will mean that the tensioning belt is tightened and the Top-Loading DAA TL pressure tapping tee with the FRIATOP clamping unit will now be pre-tensioned on the pipe. The top-loading pressure tapping tee will be clamped onto the pipe by pressurising it with a pressure air pump.

Regarding the assembly and operation of the clamping unit, please always refer to the FRIATOP clamping unit operating instructions which are available on the Aliaxis Homepage <https://www.aliaxis.de/de/downloads>

i INFO

In the case of FRIALEN Top-Loading DAA TL Pressure Tapping Tees, the factory drill setting must never be altered before assembly work is commenced.

14.2.4. Fusion

Always observe the working steps for executing the fusion process (contacting the fusion unit, reading in the barcode and starting the fusion process, marking of the fusion joint etc.). Refer to Chapter [8.2. Fusion process, P.27](#)

The following working pressures must not be exceeded during the fusion process and until complete cooling has been achieved when implementing a fusion process on the Top-Loading DAA TL Pressure Tapping Tees on pipes carrying media:

Pipe material	PE 80		PE 100	
SDR range	17	11	17	11
Maximum permissible working pressure (bar)				
Gas	2	5	5	10
Water	8	12.5	10	16

i INFO

It is essential to observe a cooling time of 10 minutes under joining pressure after the fusion process is concluded!

The following cooling times (CT) must be adhered to after the fusion process.

Diameter (d_1 main pipe) in mm	Clamping time in minutes	Cooling time in minutes	
		Until pressurisation via the outlet	Until tapping (CT)
250 - 315 (400)	10	50	60

i INFO

The cooling time (CT) as specified on the barcode sticker corresponds to the cooling time until tapping.

i INFO

If the required time for waiting and cooling is not observed, there will be a risk of leaks from the fusion joint.

14.2.5. Tapping and commissioning

i INFO

Before tapping the main pipe, make sure that the service line has been connected and its end point is sealed. This will prevent uncontrolled discharges of media.

The service line may be pressure tested before the main pipe is tapped.

14.2.5.1. Installing the domestic service line

Implement the installation of the domestic service line. Always hereby observe the general assembly and installation requirements for electrofusion (remove/clean oxide layer). Refer to Chapter [7. Processing the FRIALEN safety fittings, P.18](#) and [8. Assembly and processing: Couplers and moulded parts, P.26](#)

i INFO

A gas-stop unit must be installed for gas service lines in accordance with DVGW Code of Practice G459-1. This gas-stop unit is a safety unit which will automatically shut-off the gas flow in the event of pipe damage, e.g. caused by excavation action or drilling work. Please observe the following chapter for processing the gas-stop unit [Chapter 9. FRIASTOP Gas-Stop Unit, P.34](#)

14.2.5.2. Pressure test

The domestic service line must always be pressure tested in accordance with DVGW Code of Practice G469 (for gas applications) and W400 (for water applications). The pressure test can be executed with the FWDPA pressure test adapter.

14.2.5.3. Tapping

i INFO

The main pipe can be tapped after the cooling time (CT) has elapsed and, if applicable, a pressure test has been executed.



Image 80:

Remove the sealing plug located on the dome of the Top-Loading DAA TL Pressure Tapping Tee.

Rotate the drill bit clockwise evenly down to the lower end-stop position by utilising the suitable hexagon socket spanner FWSS 19 (spanner size 19). Tapping the pipe has now been successful.

Now rotate the drill bit back anti-clockwise to the upper end-stop position.

Apply the sealing plug and screw it down with the hexagon socket spanner until the coupler of the sealing plug lightly touches the face of the tapping stack.

Then turn the sealing plug back again by half a turn in order to release the O-ring.

14.2.5.4. Access protection for the tapping dome

It is recommended that the tapping dome is always sealed off with a DK closing cap as access protection. The DK closing cap must always be prepared for electrofusion in accordance with the general assembly requirements (mark and clean the fusion zone, remove the oxide layer etc.). Refer to Chapter 7. [Processing the FRIALEN safety fittings, P.18](#)

i INFO

If hydrogen (H₂) will be utilised in the pipe, then the Top-Loading DAA TL pressure tapping tees must always be installed with a DK closing cap.

14.3. DAV RED SNAP Pressure Tapping Valves

14.3.1. About the product



Image 81:

The FRIALEN DAV RED SNAP pressure tapping valve is a tapping valve suitable for the connection of supply lines with a branch line by tapping the supply line. The HD-PE supply line can be pressurised or without pressure and is suitable for use with gas, water and H₂.

Assembling the FRIALEN pressure tapping valves will be executed on the HD-PE pipe by utilising the innovative and patented RED SNAP fast-clamping lever.

14.3.2. Product description



Image 82:

▪ DAV RED SNAP:

Processing range (maximum permissible working pressure):

Water 16 bar / gas 10 bar

Processing-capable on PE pipes with SDR range 11 to 17.6 in a dimension range from d₁ 50 to d₁ 225.

Always observe the SDR details provided on the barcode.

14.3.3. Preparatory work and installation

The DAV RED SNAP pressure tapping valve will be assembled on the PE pipe without any additional tools by using the patented RED SNAP fast-clamping lever.

The assembly area on the PE pipe must always be correctly prepared for electrofusion in accordance with the general assembly and installation requirements (mark and

clean the fusion zone, remove the oxide layer etc.). Refer to Chapter 7. [Processing the FRIALEN safety fittings, P.18](#)



Position the DAV RED SNAP pressure tapping valve on the processed pipe surface and then guide the under clamp around the pipe.

Image 83:



Insert the clamping surface of the RED SNAP fast-clamping lever into the clamping strip of the upper saddle part. Always ensure that the clamping strip is correctly positioned in the saddle mounting area.

Image 84:



Actuating the RED SNAP fast-clamping lever upwards will clamp and tension the DAV RED SNAP pressure tapping valve firmly onto the pipe.

Image 85:

I INFO

The elastic design which is incorporated into the clamping mechanism (fast-clamping lever) of the DAV RED SNAP pressure tapping valve can also cover large pipe tolerances and therefore always ensures an optimum and even build-up of fusion pressure during the fusion process. The clamping mechanism, with its elastic design, is provided for a one-off application usage. Always therefore prevent unnecessary clamping operations before fusion, especially when the pipe is already expanded. The clamping force can otherwise be reduced and can therefore create a negative effect on the fusion result. Releasing the clamping in order to align the pressure tapping valve on the pipe is of course permissible.

I INFO

Never rotate it on the square edge: The factory drill setting must never be altered before the fusion process is commenced for pressure tapping valves.

14.3.3.1. Assembly in confined spaces

The DAV RED SNAP pressure tapping valve can also be assembled in areas where the space is limited e.g. in parallel laid pipes.

Please observe the chapter for [14.1.3.1. Assembly in confined spaces, P.59](#)

14.3.4. Fusion

Always observe the working steps for executing the fusion process (contacting the fusion unit, reading in the barcode and starting the fusion process, marking of the fusion joint etc.). Refer to Chapter [8.2. Fusion process, P.27](#)

The following working pressures must not be exceeded during the fusion process and until complete cooling has been achieved when implementing a fusion process on the DAV RED SNAP pressure tapping valve on pipes which are carrying media:

Pipe material	PE 80		PE 100	
SDR range	17	11	17	11
Maximum permissible working pressure (bar)				
Gas	2	5	5	10
Water	8	12.5	10	16

The following cooling times (CT) must be adhered to after the fusion process.

Diameter (d ₁ main pipe) in mm	Cooling time (CT) in minutes
50	20
63 / Outlet d ₂ < 63	20
63 / Outlet d ₂ 63	25
75	20
90	13
110	16
125 - 140	18
160 - 225	28

i INFO

The cooling time (CT), which has been specified on the barcode sticker of the DAV RED SNAP pressure tapping valve always corresponds to not only the cooling time until pressurisation via the outlet but also the cooling time until tapping.

i INFO

If these waiting times are not observed, there will be a risk of leaks from the fusion joint.

14.3.5. Tapping and commissioning

14.3.5.1. Installing the domestic service line



Execute the domestic service line installation. Always observe the general assembly requirements for electrofusion units (remove oxide layers/cleaning). Refer to Chapter 7. [Processing the FRIALEN safety fittings](#), P.18 and 8. [Assembly and processing: Couplers and moulded parts](#), P.26

Image 86:



Image 87:

i INFO

A gas-stop unit must be installed for gas service lines in accordance with DVGW Code of Practice G459-1. This gas-stop unit is a safety unit which will automatically shut-off the gas flow in the event of pipe damage, e.g. caused by excavation action or drilling work. Please observe the following for processing and preparing the gas-stop unit, Chapter 9. [FRIASTOP Gas-Stop Unit](#), P.34

14.3.5.2. Pressure test

The domestic service line must always be pressure tested in accordance with DVGW Code of Practice G469 (for gas applications) and W400 (for water applications).

14.3.5.3. Tapping

i INFO

Always utilise a suitable operating key with wrench size 14mm e.g. the operating key type E in accordance with DIN 3223 in order to drill the DAV RED SNAP pressure tapping valve.



Image 88:

The DAV RED SNAP pressure tapping valve can be tapped by using an operating key with wrench size 14mm or tapping can be subsequently executed by using the DBS installation set from the street cap.

Rotate the drill bit evenly in a clockwise direction (to the right) to the lower end stop. The pressure tapping valve is now closed.

The drill bit must be rotated in an anti-clockwise direction (to the left) back to the upper end stop in order to open the pressure tapping valve.

i INFO

Tapping is executed by rotating the drill anti-clockwise (closing rotating to the left) and opening clockwise (rotating to the right) with DAV RED SNAP ACW pressure tapping valves.

The DAV RED SNAP ACW pressure tapping valve is characterised by two circumferential rings located on the spindle.

The number of rotation turns for the "Open" - "Close" operation process for the DAV RED SNAP pressure tapping valve varies according to the dimension of the main pipe d_1 .

Diameter (main pipe d_1) in mm	Number of rotation turns "Open" - "Close"
50 - 75	7
90 - 140	8
160 - 225	9

I INFO

The tapping procedure needs less turns because the drill is already positioned in the intermediate position.

14.3.5.4. Commissioning



Image 89:

Select the installation set: Please select a suitable installation set according to the required function and coverage height. Assemble the selected installation set according to the manufacturer's specification.

The FRIALEN DBS installation set can be telescoped incrementally. It is optimally coordinated for the DAV RED SNAP.

The FRIALEN DBS installation set will be connected with the 14 mm square units from the DAV RED SNAP pressure tapping valve and secured against being pulled out by the KlickFix system.



Image 90:

The installation set is equipped with a sleeve tube bell with an integrated latching function. The integrated latching function, which positively connects the installation set to the DAV RED SNAP, ensures that unintentional loosening is prevented. A moss rubber ring, which is integrated into the sleeve bell, always prevents dirt from entering the installation set.

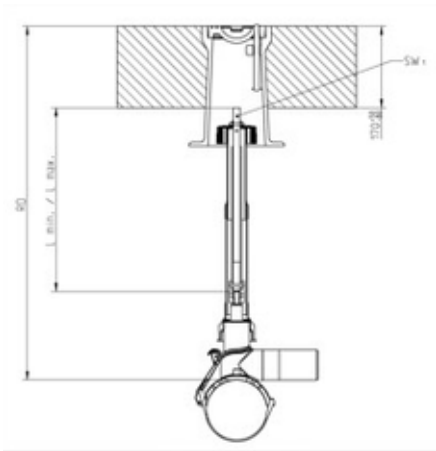

The required coverage height (RD = pipe cover) can be set on the telescopic actuating rod in the specified range (L_{\min} / L_{\max}) without any tools. The telescopic rod can be incrementally adjusted and remains stationary at any extension length.

Image 91:

i INFO

The FRIALEN DBS installation set is designed to enable commissioning of pre-laid connection pipes by drilling and tapping directly into the main pipe from the street cap.

The metal upper and lower end stops for the "Open" and/or "Closed" positions of the DAV RED SNAP pressure tapping valve result in a clearly perceptible increase in actuating force. Excessively tight closing is not required because sealing in the closed position is always executed by using a radially pressed O-ring.

14.4. Top-Loading DAV TL Pressure Tapping Valves

14.4.1. About the product



Image 92:

The FRIALEN Top-Loading DAV TL Tapping Valves are utilised as a branch fitting in unpressurised or pressurised PE pipes for variable adaptation to all pipe diameters in the specified range. Assembling the FRIALEN Top-Loading DAV TL Tapping Valves on the HD-PE distribution pipe will be executed by utilising the FRIATOOLS FRIATOP clamping unit (please refer to the FRIATOOLS operating instructions for the "FRIATOP clamping unit" for additional processing information on the Aliaxis Homepage <https://www.aliaxis.de/de/downloads>)

14.4.2. Product description

- DAV TL

Processing range (maximum permissible working pressure): Water 16 bar / Gas 10 bar
Processing-capable on PE pipes with SDR range 11 to 17.6 with a FRIATOP clamping unit, cross-dimensional processing in the dimension range from d 250 to d 315 (Order No. 616464) and d 355 - d 400 (Order No. 616465).

14.4.3. Processing

The Top-Loading DAV TL pressure tapping valves will be assembled on the PE pipe by using the FRIATOP clamping unit.

The assembly area on the PE pipe must always be correctly prepared for electrofusion in accordance with the general assembly and installation requirements (mark and clean the fusion zone, remove the oxide layer etc.). Refer to Chapter 7. [Processing the FRIALEN safety fittings, P.18](#)



Image 93:

Position the Top-Loading DAV TL pressure tapping valve on the pipe surface which is to be processed. Place the adapter, which has been deemed to be suitable for the component to be processed, on the dome of the DAV TL. Place the housing of the FRIATOP clamping unit on the adapter and the dome of the Top-Loading DAV TL pressure tapping valve. Guide the FRIATOP clamping unit tensioning belt around the pipe. Turning the star knob on the housing will mean that the tensioning belt is tightened and the Top-Loading DAV TL pressure tapping valve, with the FRIATOP clamping unit, will now be pre-tensioned on the pipe. The top-loading pressure tapping valve will be clamped onto the pipe by pressurising it with a pressure air pump.

Always observe the FRIATOP clamping unit operating instructions for the assembly and operation of the clamping unit, which are available on the Aliaxis Homepage <https://www.aliaxis.de/de/downloads>

14.4.4. Fusion

Always observe the working steps for executing the fusion process (contacting the fusion unit, reading in the barcode and starting the fusion process, marking of the fusion joint etc.). Refer to Chapter 8.2. [Fusion process, P.27](#)

The following working pressures must not be exceeded during the fusion process and until complete cooling has been achieved when implementing a fusion process on the Top-Loading DAV TL Pressure Tapping Valves on pipes which are carrying media:

Pipe material	PE 80		PE 100	
	SDR range	17	11	17
Maximum permissible working pressure (bar)				
Gas	2	5	5	10
Water	8	12.5	10	16

i INFO

It is essential to observe a cooling time of 10 minutes under joining pressure after the fusion process is concluded!

The following cooling times (CT) must be adhered to after the fusion process.

Diameter (d ₁ main pipe) in mm	Clamping time in minutes	Cooling time in minutes	
		Until pressurisation via the outlet	Until tapping (CT)
250 - 315	10	50	60
355 - 400	10	50	60

i INFO

The cooling time (CT) as specified on the barcode sticker corresponds to the cooling time until tapping.

i INFO

If the required time for waiting and cooling is not observed, there will be a risk of leaks from the fusion joint.

14.4.5. Tapping and commissioning

14.4.5.1. Installing the domestic service line

Execute the domestic service line installation. Always hereby observe the general assembly requirements for electrofusion units (remove oxide layers/cleaning). Refer to Chapter 7. [Processing the FRIALEN safety fittings, P.18](#) and 8. [Assembly and processing: Couplers and moulded parts, P.26](#)

i INFO

A gas-stop unit must be installed for gas service lines in accordance with DVGW Code of Practice G459-1. This gas-stop unit is a safety unit which will automatically shut-off the gas flow in the event of pipe damage, e.g. caused by excavation action or drilling work. Please observe to processing instructions for the gas-stop unit Chapter 9. [FRIASTOP Gas-Stop Unit, P.34](#)

14.4.5.2. Pressure test

The domestic service line must always be pressure tested in accordance with DVGW Code of Practice G469 (for gas applications) and W400 (for water applications).

14.4.5.3. Tapping

i INFO

Always utilise a suitable operating key with wrench size 14 mm e.g. the operating key type E in accordance with DIN 3223 in order to tap the Top-Loading DAV TL tapping valve.

The Top-Loading DAV TL tapping valve can be tapped by using an operating key with wrench size 14 mm or tapping can be subsequently executed by using the DBS installation set from the street cap.

Rotate the drill bit evenly in a clockwise direction (to the right) until it reaches the lower end stop. The tapping valve is now closed. The drill bit must be rotated in an anti-clockwise direction (to the left) back to the upper end stop in order to open the tapping valve.

i INFO

The metal upper and lower end stops for the "Open" and/or "Closed" positions of the Top-Loading DAV TL tapping valve result in a clearly perceptible increase in actuating force. Excessively tight closing is not required because sealing in the closed position is always executed by using a radially pressed O-ring.

14.4.5.4. Commissioning

Connect the SW14 actuating square unit of the Top-Loading DAV TL tapping valve to the FRIALEN DBS installation set and secure against being pulled out by using a split pin.

Set the required overlap height on the telescopic and incrementally adjustable actuating rod. The DBS installation set will remain securely in place at any extension length.

15. Saddle with spigot, top-loading

15.1. About the product



Image 94:

Pipe branches or vents can be easily created with the FRIALEN Top-Loading SA TL spigot end. This replaces the cost-intensive T-piece connection work. FRIALEN couplers or fittings fit onto the SA TL outlet spigot. The FRIALEN saddle with Top-Loading SA TL spigot end will be applied with the FRIATOOLS FRIATOP clamping unit. The FRIATOP clamping unit is a cross-dimensional processing, universal clamping tool which can be used across a range of dimensions from d_1 250 to 560.

15.1.1. Clamping unit scope of delivery



Image 95:

The FRIATOP clamping unit comprises the following components:

- Housing
- Compressed air pump with air hose
- Adapter (2 Pcs.) for spigot saddles and top-loading saddle moulded parts

15.2. Product description



Image 96:

▪ SA TL

Processing range (maximum permissible working pressure): Water 16 bar / Gas 10 bar

Processing-capable on PE pipes with SDR range 11 to 17.6 with a FRIATOP clamping unit, with cross-dimensional processing in the dimension range from d_1 250 to 560.

Outlet spigot with d_2 in dimensions d 32 and d 63 are available.

15.3. Preparatory work and installation

The saddle with a vacuum-loading spigot end will be applied with the FRIATOP clamping unit. The FRIATOP clamping unit is a universally applicable tool for the dimension range of d 250 to d 560.

The assembly area on the PE pipe must always be correctly prepared for electrofusion in accordance with the general assembly and installation requirements (mark and clean the fusion zone, remove the oxide layer etc.). Refer to Chapter 7. [Processing the FRIALEN safety fittings, P.18](#)

15.3.1. Assembling the saddle on the pipe

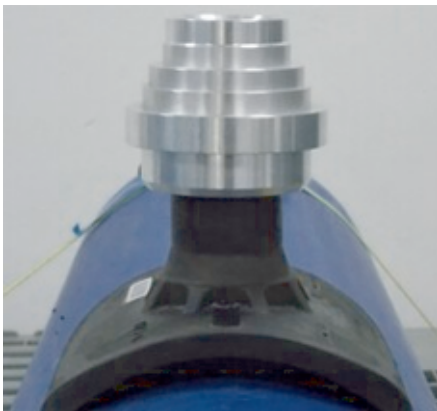

Image 97:

Assembling the saddle with Top-Loading SA TL spigot end will be executed with the FRIATOP clamping unit.

- Place the saddle on the prepared pipe surface.
- Position the adapter which is suitable for the component on the outlet spigot of the saddle with Top-Loading SA TL spigot end.
- Assemble the FRIATOP clamping unit in accordance with the operating instructions.

i INFO

Always observe the FRIATOP clamping unit operating instructions when selecting the adapter and assembling the housing, refer to Homepage <https://www.aliaxis.de/de/downloads>



Image 98:

- Place the housing of the clamping unit on the adapter and the saddle with the Top-Loading SA TL spigot end.
- Place the tensioning belt around the pipe and thread it into the pull-up rollers on the star knob.
- Turning the star knob will tighten the belt and pre-assemble the clamping unit.
- Connect a compressed air pump to the connector located on the housing.
- Pumping with the compressed air pump will enable the housing to be pressed apart and the SA TL saddle will be clamped onto the pipe without a gap.
- Unlock the clamping lever on the air hose and pull the air hose off the valve.
- Inspect again whether the SA TL saddle is positioned on the pipe without any gaps and then execute the fusion.

i INFO

Executing the fusion when media is leaking is forbidden!

i INFO

After the fusion time has elapsed, always wait ten minutes in a clamped condition before the FRIATOP clamping unit can be safely dismantled.

i INFO

Failure to comply with the stated clamping times and cooling times can result in a leaking fusion joint!

Dismantling the FRIATOP clamping unit: Release the air pressure by opening the valve and compress the unit back to its original condition. Releasing the tensioning belt will be executed by pulling on the recessed grip. Always subsequently store the clamping unit in the transport box as clean and dry.

15.4. Tapping and commissioning

▲ CAUTION

Carbide cutting edges on the hole saw

A danger of injury to the hands exists when removing the drill core and the chips. Always wear protective gloves.

i INFO

Tapping will be executed in a depressurised condition or under pressure via a shut-off valve with commercially available tapping equipment. We especially recommend suitable drilling equipment for this e.g. from Hütz und Baumgarten.

i INFO

If you need assistance with selecting the drill, tapping unit or drilling equipment, then please contact the hotline at Aliaxis Deutschland GmbH, telephone number: +49 621 486-1486.

For commissioning, implement the domestic service line installation. Always hereby observe the general assembly requirements for electrofusion (remove oxide layers/cleaning). Refer to [Chapter 7. Processing the FRIALEN safety fittings, P.18](#) and [8. Assembly and processing: Couplers and moulded parts, P.26](#)

16. Saddle with spigot, universal

16.1. About the product

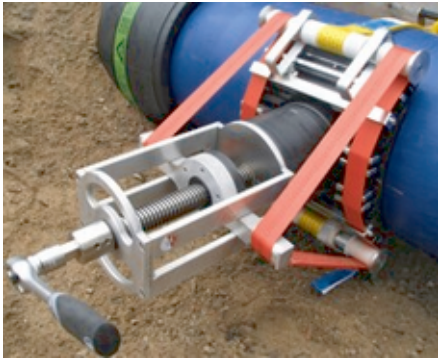
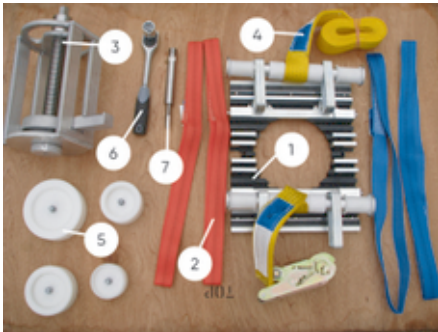

Image 99:

Pipe branches or vents can be easily created with the FRIALEN SA UNI universal saddle with spigot end. This replaces the cost-intensive integration of T-pieces. FRIALEN couplers or fittings fit onto the SA UNI outlet spigot. The FRIALEN saddle with universal SA UNI spigot end will be applied with the FRIATOOLS UNITOP and UNITOP 250 clamping unit. The UNITOP/UNITOP 250 clamping unit is a cross-dimensional processing universally applicable clamping tool.

16.1.1. Clamping unit UNITOP scope of delivery

The UNITOP clamping unit comprises the following components:



1. Clamping plate
2. Tensioning belts (respectively 2 pcs. colour = BLUE / respectively 2 pcs. colour = RED)
3. Clamping unit
4. Lower belt
5. Adapter for outlet spigots in d 90, d 110, d 125 and d 160
6. Ratchet
7. Pressure test adapter FWDP SA (optional)

Image 100:

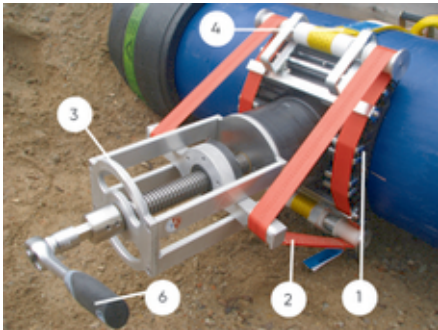

Image 101:

16.1.2. Clamping unit UNITOP 250 scope of delivery

The UNITOP 250 clamping unit comprises the following components:

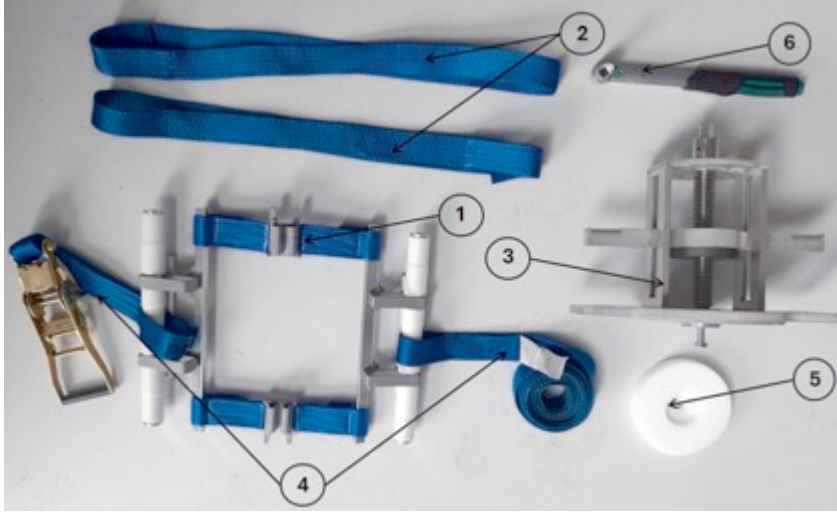

Image 102:

1. Clamping mat
2. Tensioning belts
3. Clamping unit
4. Lower belt
5. Adapter for
 - a. SA UNI for outlet spigot d 225
 - b. SA UNI for outlet spigot d 250
6. Torque wrench
7. Pressure test adapter FWDPA-SA (optional, order no. 613596, not shown in image)

16.2. Product description

16.2.1. SA UNI



Image 103:

▪ SA UNI

Processing range (maximum permissible working pressure): Water 16 bar / Gas 10 bar

Processing-capable on PE pipes with SDR range 11 to 26 with a UNITOP clamping unit, with cross-dimensional processing in the dimension range from;

- d_1 250 - d_1 280
- d_1 315 - d_1 400
- d_1 450 - d_1 900

Outlet spigot with d_2 in dimensions d 90, d 110, d 125 and d 160 are available.

16.2.2. SA UNI 225 - 250



Image 104:

▪ SA UNI 225 - 250

Processing range (maximum permissible working pressure): Water 16 bar / Gas 10 bar

Processing-capable on PE pipes with SDR range 11 to 26 with a UNITOP 250 clamping unit, with cross-dimensional processing in the dimension range from;

- d_1 315 - d_1 355
- d_1 400 - d_1 450
- d_1 500 - d_1 630
- d_1 710 - d_1 900
- d_1 1000 - d_1 1200

Outlet spigot with d_2 in dimensions d 225 and d 250 are available.

16.3. Preparatory work, assembly and installation with the clamping unit

The saddle with a universal spigot end will be applied with the UNITOP or UNITOP 250 clamping unit. The UNITOP/UNITOP 250 clamping unit is a universally applicable tool for all dimensions.

The assembly area on the PE pipe must always be correctly prepared for electrofusion in accordance with the general assembly and installation requirements (mark and clean the fusion zone, remove the oxide layer etc.). Refer to Chapter 7. [Processing the FRIALEN safety fittings, P.18](#) and 8. [Assembly and processing: Couplers and moulded parts, P.26](#)

i INFO

The described sequence of working steps must always be adhered to.

16.3.1. Assembling the saddle SA UNI on the pipe

⚠ CAUTION

Danger of injury when the belt ratchet is open

The clamping lever of the belt ratchet must be locked in the closed position again after the assembly has been completed.



Position the clamping plate (1) on the saddle with the Universal SA UNI spigot.

i INFO

Always ensure that the SA UNI rests on a clean and dry surface.

Image 105:



Image 106:

Place the SA UNI together with the pre-assembled clamping plate on the prepared pipe surface.

i INFO

Always ensure that the ratchet is handled correctly and that the lower belt is threaded in correctly.

The lower belt (4) is attached to the clamping beams of the clamping plate. Loop the lower belt around the pipe and insert the loose end of the lower belt into the belt ratchet. Actuating the belt ratchet will position the clamping plate with the SA UNI saddle on the pipe.

i INFO

Hand-tighten the lower belt by only using the ratchet!
The SA UNI saddle will be initially pre-assembled, the clamping is only executed in the next work step.

i INFO

Always ensure that the lower belt is not twisted and is positioned in the centre within the guides of the clamping beams.

16.3.2. Assembling the UNITOP clamping unit

i INFO

Before installing the clamping unit (3), always ensure that the cross beam of the clamping unit is located in the end position.



Select the appropriate adapter (5) for the outlet spigot of the SA UNI (d 90, d 110, d 125 and d 160) and screw the adapter to the clamping unit (3).

Image 107:



Select the upper (red or blue) tensing belts (2) according to the dimension range (see table below) and thread both tensing belts into the attachment points of the tensing beams of the tensing plate (1).

Image 108:

Main pipe d_1	Upper tensing belt colour
250 – 280	Blue
315 – 400	Red
450 – 900	Red

Assemble the clamping unit on the outlet spigot of the saddle with Universal SA UNI spigot.



Image 109:

Insert the adapter, which is screwed onto the clamping, into the outlet spigot of the SA UNI to achieve this.

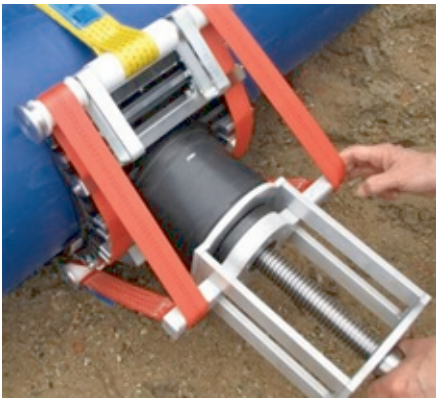

Image 110:

Hold the clamping unit in this position and place the two tensioning belts around the cross beam so that the clamping unit, clamping plate and SA UNI are firmly positioned on the pipe.



Image 111:

Always hereby ensure that the UNITOP clamping unit, the saddle with the SA UNI spigot and the tensioning belts are aligned vertically and straight. If necessary, correct the position of the SA UNI on the pipe.

i INFO

If necessary, always secure the position to prevent unintentional slipping of the saddle with the SA UNI spigot.

i INFO

Always ensure that the tensioning belts are centred within the guides of the clamping beam on the clamping plate (1) as well as the cross beam on the clamping unit (3)!

Never twist the tensioning belts!

Before the clamping unit is actuated, always inspect the correct position of the saddle with the Universal SA UNI spigot again after assembling the UNITOP clamping unit on the pipe!

16.3.3. Assembling the saddle SA UNI 225 - 250 on the pipe

⚠ CAUTION

Crush hazard when clamping

Injuries to the hand

- ▶ Do not reach under the belt or clamping plate during pre-assembly.
- ▶ Ensure that the belt is in the correct position.
- ▶ Ensure that you use the belt ratchet correctly ⇒ the belt is under tension.
- ▶ After pre-assembly, lock the ratchet clamping lever in the closed position.

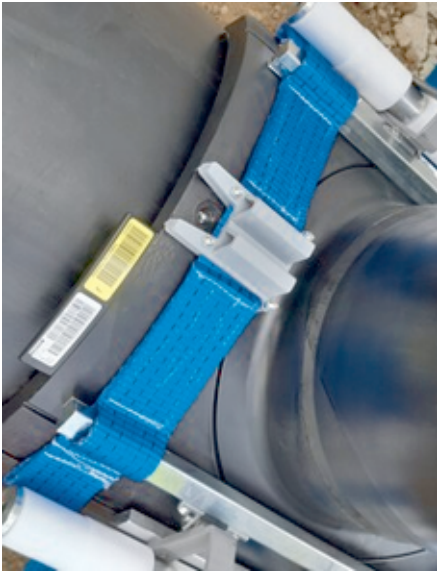

Image 112:



Place the SA UNI 225 / 250 saddle component on the prepared pipe surface and then guide the clamping mat via the outlet of the SA UNI saddle component.

Image 113:



The clamping mat must rest correctly on the saddle and the crown stop must be positioned flush with the outer edge of the saddle.

Image 114:



Image 115:

During pre-assembly, ensure that the lower belt is not twisted and is positioned centrally within the guides of the tensioning bars.

The lower belt is attached to the clamping bars of the clamping mat. Loop the lower belt around the pipe and insert the loose end of the lower belt into the belt ratchet. Operate the belt ratchet to (pre-)position the saddle with outlet spigot universal SA UNI on the pipe.

i INFO

The saddle with outlet spigot universal SA UNI must be firmly clamped (hand-) tight onto the pipe. The saddle is first pre-assembled, and clamping takes place in the next work step.

16.3.4. Assembling the UNITOP 250 clamping unit

i INFO

Select the correct adapter for the outlet spigot d 225 or d 250 of the saddle component SA UNI and screw it firmly onto the clamping unit. Ensure that the crossbar of the clamping unit is in the front end position before installing the clamping unit.



Image 116:

Mount the clamping unit on the outlet of the SA UNI.
To do this, the clamping unit with mounted adapter must be inserted into the outlet of the SA UNI.



Image 117:

Hold the clamping unit firmly in this position, it is vital to achieve the correct alignment of the clamping unit to the SA UNI.
Place both tensioning belts around the crossbar. The clamping unit, clamping mat and the SA UNI must now be securely positioned on the pipe.



Image 118:

Ensure that the UNITOP 250 clamping unit, the SA UNI saddle component and the tensioning belts are aligned vertically and straight. If necessary, correct the position of the SA UNI on the pipe.



Image 119:

When mounting the tensioning belt, make sure that the belt seam is positioned above the crown stop, as this will ensure uniform clamping.

16.4. Actuating the UNITOP clamping unit

⚠ CAUTION

Danger of crushing!

Injuries to hands or on the arm area.

Never reach under the clamping plate or the saddle component when actuating the clamping unit.

⚠ CAUTION

The belts are always tensioned!

Failure of the tensioning belt can result in injuries.

Always inspect the fault-free condition of the belts before commissioning and utilising the UNITOP clamping unit. Worn or old belts must always be exchanged. Only utilise original spare parts from Aliaxis Deutschland GmbH.

HINT

Never attach an extension to the ratchet.

The larger, increased leverage can damage the clamping unit.

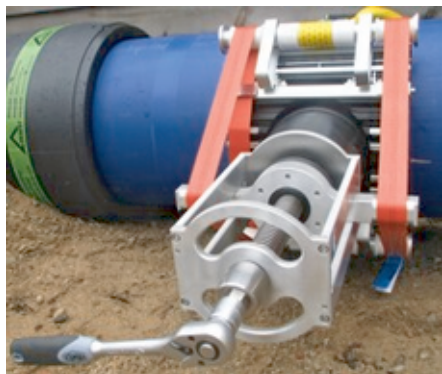

Clamp the saddle with the Universal SA UNI spigot end onto the pipe. Place the ratchet with the nut on the spanner location surface of the threaded spindle and then turn clockwise until the SA UNI rests on the pipe surface without any **gap** to create this.

Image 120:



Always ensure that the contact eye of the SA UNI is located in the recess provided in the clamping plate during the assembly work.

Image 121:

Remove the ratchet and put it back in the transport box after actuating the clamping unit.

16.5. Actuating the UNITOP 250 clamping unit

▲ CAUTION

The belts are under tension

Injuries to the body or face

Observe the general safety guidelines, such as

- ▶ Regular inspections of the belts, particularly before each assembly,
- ▶ Ensure the correct belt installation,
- ▶ Replace of worn and old belts,
- ▶ Only use belts approved by the manufacturer,
- ▶ Maintain a safe distance when operating the clamping unit,
- ▶ Use personal protective equipment such as gloves or a safety helmet.

⚠ CAUTION

Operating the clamping unit

Crush hazard

Do not reach under the clamping plate or the saddle component when the clamping unit is in operation.



Image 122:

The following must be observed before operating the clamping unit:

Make sure that the tensioning belts are positioned correctly, they must be positioned centrally within the guides of the clamping bar on the clamping mat and the crossbar on the clamping unit.

The tensioning belts must not be twisted when mounted. After mounting the UNITOP 250 clamping unit on the pipe, check the correct position of the SA UNI saddle component.

The assembly should look as shown in the illustration.

Clamp the saddle with outlet spigot universal SA UNI onto the pipe.



Image 123:

To do this, place the ratchet with the nut on the wrench flat of the threaded spindle. Turn clockwise (i.e. to the right) until the saddle with outlet spigot universal SA UNI rests on the pipe surface **with no gaps** and a "crack" sound can be clearly heard on the ratchet.

The "crack" is the acoustic signal that the saddle with outlet spigot SA UNI has reached the optimal position on the pipe surface.

Then remove the ratchet and place it back in the transport box.

i INFO

When operating the clamping unit, do not use an extension on the ratchet, as this may damage the unit.

16.6. Fusion

▲ CAUTION

Plastic melt escaping during the fusing process

Burns on the skin

Always maintain a distance of one metre from the fusing site during the fusion process for general safety reasons.

Always observe the working steps for executing the fusion process (contacting the fusion unit, reading in the barcode and starting the fusion process, marking of the fusion joint etc.). Refer to Chapter [8.2. Fusion process, P.27](#)

i INFO

Always inspect, correct if necessary, the correct position of the clamping unit as well as controlling the gap-free positioning for the saddle on the pipe! If necessary, the saddle must be clamped on again.

i INFO

When using the UNITOP clamping unit (not required for UNITOP 250):

Should your fusion unit already be equipped with straight fusing plugs, then you will also need ADWL bend adapters (Order No. 613241). FRIAMAT fusion units are already equipped with angled connectors as standard.

i INFO

Pre-heat SA UNI 225 / 250 before starting the fusion process.

Please also refer to the FRIALEN Safety Fittings assembly instructions for information on the pre-heating and fusion process steps. Current instructions are available online at <https://www.aliaxis.de/en/downloads>



Image 124:

For the saddle with outlet spigot universal SA UNI with outlet spigot d 225 and d 250 there is a barcode sticker for pre-heating (yellow barcode sticker) on the component in addition to the barcode sticker (white barcode sticker) with the fusion and traceability barcode.



Image 125:

The fusion parameters are read into the fusion unit with a reading wand or a hand-held scanner.

Execute the fusing.

After the fusing time has elapsed, the fusion unit can be switched off and the fusing cable can be disconnected. Never dismantle the UNITOP or UNITOP 250 clamping unit before the cooling time (CT) has elapsed.

d ₁	d ₂	Cooling time in minutes after the fusion time has elapsed until	
		... dismantling the clamping unit.	... Pressure test via the outlet spigot (CT).
250-280	90-160	20	60
315-400	90-160	20	60
450-900	90-160	20	60
315-355	225-250	20	60
400-450	225-250	20	60
500-630	225-250	20	60
710-900	225-250	20	60
1000-1200	225-250	20	60

d ₁	d ₂	Cooling time in minutes after the fusion time has elapsed until	
		Tapping or drilling on unpressurised pipes possible (without pressure test)	Tapping and drilling for under working pressure.

i INFO

The cooling time (CT) is indicated on the barcode of the saddle with the Universal SA UNI spigot end. It is recommended that a pressure test is always executed on the main pipe before commencing any tapping work.

i INFO

Failure to comply with the clamping times and cooling times can result in a leaking fusion joint.

16.7. Dismantling the UNITOP clamping unit

⚠ CAUTION

Danger of injury if the ratchet lock is released.

If it is utilised incorrectly, then kickback on the operator's hand is possible. Always take care when releasing the locking part.

Use the ratchet to loosen the spindle nut and turn it until the cross beam is located in the lower position.

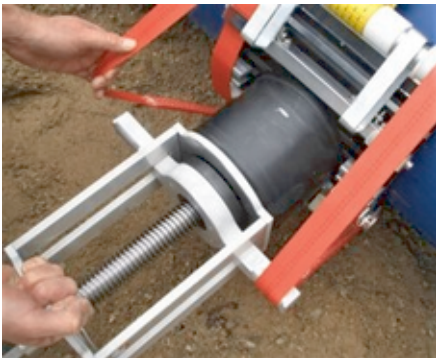

Image 126:

Secure the clamping unit by holding it firmly and release the tensioning belts from the cross beam.

When finished, remove the clamping unit from the outlet of the SA UNI and place the clamping unit back into the provided transport box.



Image 127:

Loosen the lower belt on the pipe, by opening the belt ratchet and then pull the clamping plate over the saddle outlet with the Universal SA UNI spigot.

Then store the clamping plate in the transport box as clean and dry.

16.8. Dismantling the UNITOP 250 clamping unit

▲ CAUTION

Risk of injury caused by dismantling the clamping unit.

Injuries to the hand and/or upper body caused by tensioned belts. Incorrect installation or failure may cause a recoil when loosening the ratchet locking mechanism

- ▶ of the belt or
- ▶ the belt ratchet.

Maintain a safe distance of roughly an arm's length when releasing the locking mechanism.



Image 128:

Turn the ratchet counterclockwise to loosen the spindle nut. Turn until the crossbar is in the lower position. Secure the clamping unit to prevent it from falling.

i INFO

Secure the clamping unit to prevent it from falling when releasing the spindle nut.



Image 129:

Then release the tensioning belts from the crossbar.



Image 130:

Then dismantle the clamping unit from the outlet of the SA UNI 225 / 250 saddle component. To do this, remove the clamping unit from the SA UNI 225 / 250 outlet and place the clamping unit back in the transport box.



Image 131:

Open the belt ratchet to loosen the lower belt on the pipe, the clamping mat can then be removed via the outlet of the SA UNI 225 / 250 saddle component. Then place the clamping mat back in the transport box.

16.9. Pressure test

Always execute a pressure test on the saddle fusion before tapping or drilling the main pipe. The FWDPA SA (Ord. No. 613596) pressure test adapter must always be utilised for this procedure.



Image 132:

The saddle with the Universal SA UNI spigot is equipped with a test connection for pressure testing in the outlet spigot.



Image 133:

Screw the FWDPA SA (7) pressure test adapter into the test connection of the SA UNI.

The face side of the pressure test adapter must be located as flush with the test connection.

The FWDPA SA pressure test adapter is equipped with a 1/2" external thread for connecting a pressure test adapter e.g. via a commercially available plug-in coupling.

i INFO

Always prevent overtightening the thread by excess tightening. When the thread is overtightened, then the pressure test cannot be executed anymore.



Connect the FWDPA SA pressure test adapter to a pressure testing unit e.g. a hand pump. A suitable pressure gauge is essential for controlling the test pressure.

Execute the pressure test.

Image 134:

Parameter for the pressure test;

Test pressure in bar	Maximum test duration [min.]	Test media
10	10	Water

A reduction factor must always be considered for temperatures > 23 °C.

16.10. Tapping and commissioning

16.10.1. Tapping the pipe (unpressurised)

▲ DANGER

Explosive and/or health-threatening gas mixtures

Injuries caused by explosion and/or inhalation of hazardous gas mixtures (e.g. residual gas, decomposing digester gas).

Always ensure that the pipe is depressurised and completely empty before any tapping.

▲ DANGER

Escaping medium (e.g. residual water) in the drilling machine.

Electric shock.

Always ensure that the pipe is completely empty and that there is no medium located in the area of the pipe bottom before tapping.

▲ CAUTION

Carbide cutting edges on the hole saw

A danger of injury to the hands exists when removing the drill core, PE plate, metal shavings and the chips.

Always wear protective gloves.



Image 135:

Tapping is to be executed with the FRIATOOLS FWAB drilling and tapping set **without** working pressure present, and with the pipes in a totally empty condition.

Please always observe the operating instructions for the FRIATOOLS FWAB drilling and tapping set. See <https://www.aliaxis.de/de/downloads>



Image 136:

The saddle with the Universal SA UNI spigot end will be tapped in two steps;

1. In the first step, the inner disc of the SA UNI including the test connection will be drilled out. Utilise a suitable hole saw without the centre drill for this.
2. In the second step, the centring drill will be fitted and the pipe wall has to be drilled through after the hole saw has been fitted again.
3. Always remove any swarf or shavings from the hole saw after tapping is completed. If necessary, also remove any swarf or shavings which may have entered the pipe.

16.10.2. Tapping the pipe (under pressure)

▲ CAUTION

Carbide cutting edges on the hole saw

A danger of injury to the hands exists when removing the drill core, PE plate, metal shavings and the chips.

Always wear protective gloves.

HINT

Incorrect handling of the drilling or tapping equipment

Leaking pipes

Pipes can be tapped under working pressure by utilising the external tapping equipment and a shut-off unit (e.g. from Hütz und Baumgarten). Please contact our hotline (Tel. +49 621 486-1486) or your local technical, specialist advisor in advance for technical application support.

Always observe the manufacturer's specifications for tapping pipe which is still under operating pressure.

8 INFO

When tapping under working pressure, the following preparatory work must be executed on the universal SA UNI saddle with spigot end.



Image 137:

When tapping under working pressure, the test connection on the SA UNI must be removed before installing the SA UNI on the pipe.

Drill out the test connection with a drill (hole saw d 50mm to d 65mm).



Universal SA UNI saddle spigot end with drilled out test connection.
Deburr the cut edge on the saddle surface (e.g. with a hand scraper tool).

Image 138:

i INFO

If you need assistance with selecting the drill, tapping unit or drilling equipment, then please contact the hotline at Aliaxis Deutschland GmbH, telephone number: +49 621 486-1486.



An external tapping equipment (e.g. from Hütz und Baumgarten) is required for drilling or tapping a pipe which is still under operating pressure, which enables the procedure by utilising a shut-off unit (e.g. FRIALOC).

Image 139:



The drill core, PE swarf and the PE plate which has been drilled out are trapped in the milling unit after tapping has been executed correctly. They will be pushed out with the aid of the ejector.

Image 140:

16.10.3. Commissioning

Execute the domestic service line installation. Always hereby observe the general assembly requirements for electrofusion (remove oxide layers/cleaning). Refer to Chapter 7. [Processing the FRIALEN safety fittings, P.18](#) and 8. [Assembly and processing: Couplers and moulded parts, P.26](#)

16.11. Care and maintenance

- All the components of the UNITOP clamping unit must be cleaned regularly in order to remove dirt and deposits. Never utilise aggressive cleaning agents for this task.
- The UNITOP clamping unit must always be protected against soiling. The unit and all accessories must be stored in a dry and clean place, preferably in the transport box which has been provided.
- The temperature range for storage is located between $-20\text{ }^{\circ}\text{C}$ and $+70\text{ }^{\circ}\text{C}$.
- The tensioning belts must be inspected at regular intervals. Worn and/or damaged tensioning belts must always be replaced.
- Only utilise original tensioning belts which have been approved by Aliaxis Deutschland GmbH. Never utilise aggressive cleaning agents to clean the tensioning belts to prevent damaging them.
- Alterations, additions or conversions must never be executed on the unit without the prior, express approval of Aliaxis Deutschland GmbH.

I INFO

A regular, annual test and inspection for functional safety is recommended as a service from the service department of Aliaxis Deutschland GmbH or our service stations.

17. Saddle with spigot, vacuum loading

17.1. About the product



Image 141:

Pipe branches or vents can be easily created with the FRIALEN vacuum-loading SA VL saddle with spigot end. This replaces the cost-intensive integration of T-pieces. FRIALEN couplers or fittings fit onto the SA VL outlet spigot.

The FRIALEN SA VL saddle with vacuum loading spigot end will be applied with the FRIATOOLS FRIALOAD clamping unit. The required clamping force will be applied by a vacuum.

17.1.1. Clamping unit scope of delivery



Image 142:

- Vacuum lifter (PUMP) Order No. 613810



Image 143:

- PLATE (2 pcs.) Order No. 617372 with plug-in cap
- PLATE large (d 400 mm)
- PLATE small (d 325 mm)

17.2. Product description



Image 144:

▪ SA VL (SDR 11/SDR 17)

Processing range (maximum permissible working pressure): Water 16/10 bar / Gas 10/5 bar*

Processing-capable on PE pipes with SDR range 11 to 26 with a FRIALOAD vacuum load clamping unit in the dimension range from d_1 400 to d_1 1200.

* Maximum operating pressure (in bar)		
SDR range	Water	Gas
17	10 bar	5 bar
11	16 bar	10 bar

Always consider any reduction factors e.g. at operating temperatures > 20 °C.

17.3. Preparatory work, assembly and installation with the clamping unit

The saddle with a vacuum-loading spigot end will be applied with the FRIATOP clamping unit. The FRIALOAD clamping unit generates the required joint pressure via a vacuum. The FRIALOAD is a universally applicable tool for all dimensions.

The assembly area on the PE pipe must always be correctly prepared for electrofusion in accordance with the general assembly and installation requirements (mark and clean the fusion zone, remove the oxide layer etc.). Refer to Chapter 7. [Processing the FRIALEN safety fittings, P.18](#) and 8. [Assembly and processing: Couplers and moulded parts, P.26](#)

i INFO

The described sequence of working steps must always be adhered to.

17.3.1. Assembling the saddle on the pipe

i INFO

The following images partially represent the ASA VL 225 sewage saddle.



Image 145:

Place the saddle with the spigot, vacuum loading SA VL on the prepared pipe surface area.

Select the suitable PLATE for the prepared SA VL:

- SA VL outlet spigot \geq d 250 large PLATE (d 400)
- SA VL outlet spigot \leq d 225 small PLATE (d 325)

Place the PLATE on the SA VL outlet spigot. Always ensure that the alignment clamps for the vacuum lifter (PUMP) are freely accessible.

i INFO

Inspect the rubber mat located on the back of the PLATE to ensure that it is in perfect condition before assembling the PLATE. If the rubber mat is defective, then it may not be possible to generate a vacuum. In this case, do not utilise the FRIALOAD clamping unit and contact the hotline of Aliaxis Deutschland GmbH, Tel. +49 621 486-1486.



Image 146:

Establish a connection with the pneumatic hose between the SA VL and the PLATE. Utilise the pneumatic connections which are located on the spigot saddle and on the PLATE to establish the connection.

17.3.2. Assembling the PUMP



Image 147:

Push the vacuum lifter (PUMP) in the guides onto the PLATE until it reaches the end stop.



Image 148:

Always ensure that the FRIALOAD clamping unit, with its PLATE and PUMP components, are correctly assembled before starting to generate the vacuum.

17.4. Clamping via vacuum generation

Clamping the saddle with vacuum-loading SA VL spigot is possible by utilising vacuum generation with the FRIATOP clamping unit.



Image 149:

- Switch on the On/Off main switch of the vacuum lifter (PUMP) by sliding the switch located on it to the "On" position.
- Inspect the LED display to see whether the accumulator charge level is sufficient in order to execute the assembly work for the SA VL.
- If the accumulator charge level is low, then charge it first. Refer to [Chapter 17.8. Care and maintenance, P.128](#)
- The vacuum lifter (PUMP) will be put into operation by pressing the green button.

i INFO

It can take a few seconds before the full suction power is reached after switching on the vacuum lifter (PUMP).



Image 150:

- You can support the vacuum generation process by pressing the vacuum lifter (PUMP) onto the PLATE.
- The vacuum will be generated when the vacuum lifter (PUMP) makes suction noises and the numbers on the digital display begin to increase.
- A vacuum with a minimum of -0.6 bar must be achieved then the vacuum lifter (PUMP) will switch off independently.
- The vacuum lifter (PUMP) will continue to automatically readjust the vacuum whenever necessary.

8 INFO

The vacuum **must** always be maintained throughout the entire processing time until the end of the cooling time.

17.5. Fusion

Always observe the working steps for executing the fusion process (contacting the fusion unit, reading in the barcode and starting the fusion process, marking of the fusion joint etc.). Refer to Chapter [8.2. Fusion process, P.27](#)

8 INFO

Pre-heating is specified as a requirement for optimising the matching of the SA VL and pipe joining partners and to reduce thermal loads or stresses in the joint area.

Please observe the work steps for executing pre-heating in Chapter [8.2.2. Pre-heating, P.28](#)

8 INFO

Before commencing any fusing process, always ensure that the vacuum on the digital display of the vacuum lifter (PUMP) is indicating constant at ≤ -0.6 bar.



Start the fusing.

Image 151:

Once the fusion time has elapsed, the fusion unit can be switched off and the fusing cable can be removed from the saddle with the SA VL vacuum-loading spigot. Never dismantle the FRIALOAD clamping unit before the cooling time CT has elapsed. Failure to comply with the stated cooling times and clamping times can result in a leaking fusion joint!

I INFO

The cooling time (CT) is indicated on the barcode of the saddle with the SA VL vacuum-loading spigot.

17.6. Dismantling the clamping unit

▲ CAUTION

Danger of injury caused by dismantling the clamping unit

The FRIALOAD clamping unit can suddenly fall from the outlet of the spigot saddle and therefore cause injuries when releasing the vacuum clamping unit. Always secure the FRIALOAD clamping unit against falling down when releasing the vacuum clamping unit.



Image 152:

- The vacuum can be discharged from the SA VL after the cooling time has elapsed.
- The vacuum will be switched off and the vacuum lifter (PUMP) will then detach itself from the PLATE when the red button has been pressed.
- Then slide the On/Off main switch of the vacuum lifter (PUMP) to the Off position. The vacuum lifter (PUMP) is now therefore switched off.



Image 153:

- Slide the vacuum lifter (PUMP) out of the PLATE guides.
- Stow the vacuum lifter (PUMP) in the transport box again to protect it.
- Then remove the PLATE from the outlet spigot of the SA VL.
- Also stow the PLATE in the transport box again to protect it.

17.7. Tapping and commissioning

17.7.1. Tapping the pipe (unpressurised)

▲ DANGER

Explosive and/or health-threatening gas mixtures

Injuries caused by explosion and/or inhalation of hazardous gas mixtures (e.g. residual gas, decomposing digester gas).

Always ensure that the pipe is depressurised and completely empty before any tapping.

▲ DANGER

Escaping medium (e.g. residual water) in the drilling machine.

Electric shock.

Always ensure that the pipe is completely empty and that there is no medium located in the area of the pipe bottom before tapping.

▲ CAUTION

Carbide cutting edges on the hole saw

A danger of injury to the hands exists when removing the drill core and the chips. Always wear protective gloves.



- Tapping is to be executed with the FRIATOOLS FWAB drilling and tapping set without working pressure and **with a completely emptied** pipe.
- Please always observe the operating instructions for the FRIATOOLS FWAB drilling and tapping set.
- The current instructions can be found on our homepage in the download area at <https://www.aliaxis.de/de/downloads>

Image 154:

8 INFO



Image 155:

Please consider that the drilling machine, which is to be utilised for drilling or tapping, must always be suitable for use with a hole saw holder for **SDS max. (1)** or **SDS plus (2)** – depending on the pipe wall thickness.

Always observe the recommended minimum requirements for the drilling machine such as e.g. power consumption and revolution speed range, which are included in the operating instructions for the FWAB drilling equipment!



Image 156:

- The SA VL vacuum-loading spigot saddles are to be tapped by inserting the hole saw vertically and centrally into the outlet of the SA VL and subsequently drilling through the pipe wall.
- Always remove any chips from the hole saw after tapping is completed. If necessary, also remove any swarf or shavings which may have entered the pipe.
- Always deburr the cut edge after tapping.

17.7.2. Tapping the pipe (under pressure)

An external tapping equipment (e.g. from Hütz und Baumgarten) is required for tapping pipe which is still under operating pressure, which enables tapping by utilising a shut-off unit (e.g. FRIALOC).

i INFO

Tapping or drilling the pipe which is still under working pressure with external drilling equipment: Contact our hotline in advance for technical support, Tel. +49 621 486-1486 or your local specialised consultant.

Always observe the manufacturer's specifications for tapping pipe which is still under operating pressure.

17.7.3. Commissioning

Execute the domestic service line installation. Always hereby observe the general assembly requirements for electrofusion (remove oxide layers/cleaning). Refer to Chapter 7. [Processing the FRIALEN safety fittings, P.18](#) and 8. [Assembly and processing: Couplers and moulded parts, P.26](#)

17.8. Care and maintenance

i INFO

The unit must be serviced at least once a year according to BGV A3 "Electrical installations and equipment". This can be executed for the vacuum lifter (PUMP) directly at the manufacturer GRABO LLC or at the InnoConcept OHG sales partner.

- All the components of the FRIALOAD clamping unit must be cleaned regularly in order to remove dirt and deposits. Always utilise a commercially available cleaning agent for this – do not utilise an aggressive cleaning agent.
- Never allow liquids to enter into the air path of the vacuum lifter (PUMP), the pneumatic connections on the PLATE and the pneumatic hose.
- The FRIALOAD clamping unit must always be stored in a dry and clean place. Always store it in the dry transport box after every application.
- Keep the handles and gripping surfaces dry, clean and free of oil and grease. Slippery handles and gripping surfaces will prevent safe handling of the tool.
- Only charge the vacuum lifter (PUMP) with the charger which has been specified by the manufacturer. A charger suitable for one type of accumulator can pose a fire hazard when used with another accumulator
- Only utilise the vacuum lifter (PUMP) with the accumulator which has been specifically designed for it. Utilising any other type of accumulator can create a danger of injury and fire.
- When the vacuum lifter (PUMP) accumulator is not in use, then always keep it away from other metal objects such as paper clips, coins, keys, nails, screws and other small metal objects which could create a short circuit. Short-circuiting the accumulator can cause burns or fires.
- When the vacuum lifter (PUMP) accumulator is not handled properly, then liquid can leak out of the accumulator; be sure to prevent contact with this.

- Never utilise damaged or modified accumulators or tools. Damaged or modified accumulators can behave in unpredictable ways and cause fires, explosions or create a danger of injuries.
- When the vacuum level drops noticeably even though the accumulator is fully charged, then inspect the foam seal for wear or damage. Never attempt to generate a vacuum before the seal has been replaced.

i INFO

Please refer to the FRIALOAD operating instructions for additional information regarding spare parts for the vacuum lifter (PUMP), handling the accumulator, servicing, inspection and testing intervals. Current instructions are available at <https://www.aliaxis.de/de/downloads>

18. Repair and reinforcing saddles

18.1. About the product



PE pipes can indicate the present of localised pipe damage, e.g. caused by transport, accidental drilling, excavator intervention etc.

Image 157:



Image 158:



Image 159:

In the event of localised pipe damage being present, then the damaged area can be sealed with a plug and then fused with a repair and reinforcement saddle.

18.2. Product description



Image 160:

▪ RS (Repair Saddle)

Processing range (maximum permissible working pressure): Water 16 bar / Gas 10 bar

Processing-capable on PE pipes with d_1 63 from SDR range 11 to 17.6 with under clamp.



Image 161:

- **RSV (Repair and Reinforcing Saddle)**

Processing range (maximum permissible working pressure): Water 16 bar / Gas 10 bar

Processing-capable on PE pipes with SDR range 11 to 17.6 in a dimension range from d_1 90 to d_1 225 with under clamp, repair surface area maximum 50 mm.



Image 162:

- **RS TL (Repair Saddle Top-Loading)**

Processing range (maximum permissible working pressure): Water 16 bar / Gas 10 bar

Processing-capable on PE pipes with SDR range 11 to 17.6 with a FRIATOP clamping unit, with cross-dimensional processing in the dimension range from d_1 250 to d_1 560, repair surface area maximum 50 mm.

I INFO

The damage must be located within the repair area and not in the fusion zone.

18.3. Preparatory work and installation

The FRIALEN RS, RSV and RS TL repair and reinforcement saddles will be assembled on the PE pipe by utilising an under clamp (RS and RSV) or a FRIATOP clamping unit (RS TL). The assembly area on the PE pipe must always be correctly prepared for electrofusion in accordance with the general assembly and installation requirements (mark and

clean the fusion zone, remove the oxide layer etc.). Refer to Chapter 7. [Processing the FRIALEN safety fittings, P.18](#)

18.3.1. Assembly with under clamp



Image 163:

The RS and RSV repair and reinforcement saddles will be assembled with an under clamp:

- Loosen the pre-assembled bolts on the side.
- Fold open the upper part and lower part; the side that is still screwed in serves as a hinge.
- Place on the prepared pipe surface.
- Tighten all four screwed connections evenly crosswise with a hexagon socket spanner as far as they will go.
- Spanner width for the internal hexagon bolts RS SW 5 and RSV SW 6.

i INFO

The under clamps are an integral part of the RS and RSV repair and reinforcement saddles and are utilised to apply the joining pressure.

i INFO

During the assembly process, always ensure that the damaged or deformed area of the pipe is always located in the centre of the heating element and at least 10 mm away from the inner fusion wires.

Start the fusion process after assembly is completed.

i INFO

Executing the fusion when media is leaking is forbidden!

18.3.2. Assembling with the clamping unit



Image 164:

Assembling the RS TL repair saddle will be executed with the FRIATOP clamping unit:

- Place the adapter, which has been deemed to be suitable for the component to be processed, on the RS TL repair saddle.
- Always observe the FRIATOP clamping unit operating instructions when selecting the adapter and assembling the housing, refer to Homepage <https://www.aliaxis.de/de/downloads>

i INFO

Attention must be paid to ensure that the assembly work for the damaged or deformed position on the pipe is always located within the internal repair area $d_3 = 50 \text{ mm}$.

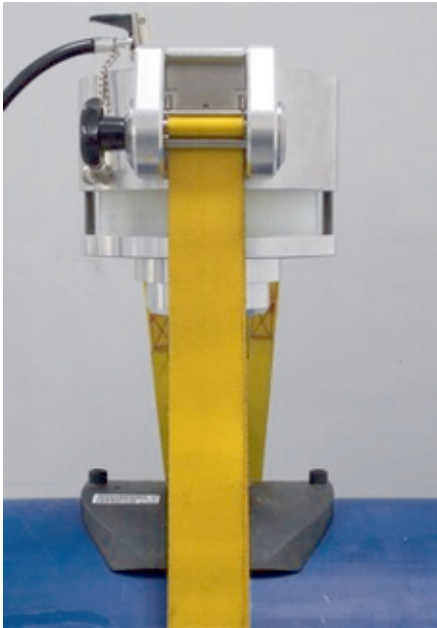

Image 165:

- Place the housing of the clamping unit on the adapter and the RS TL repair saddle.
- Place the tensioning belt around the pipe and thread it into the pull-up rollers on the star knob.
- Turning the star knob will tighten the belt and pre-assemble the clamping unit.
- Connect a compressed air pump to the connector located on the housing.
- Pumping with the compressed air pump will enable the housing to be pressed apart and the RS TL repair saddle is clamped onto the pipe without a gap.
- Unlock the clamping lever on the air hose and pull the air hose off the valve.
- Inspect again whether the RS TL repair saddle is positioned on the pipe without any gaps and then execute the fusion.

i INFO

Executing the fusion when media is leaking is forbidden!

i INFO

After the fusion time has elapsed, always wait ten minutes in a clamped condition before the FRIATOP clamping unit can be safely dismantled.

i INFO

Failure to comply with the stated clamping times and cooling times can result in a leaking fusion joint!

Dismantling the FRIATOP clamping unit: Release the air pressure by opening the valve and compress the unit back to its original condition. Releasing the tensioning belt will be executed by pulling on the recessed grip.

Always subsequently store the clamping unit in the transport box as clean and dry.

19. Retaining residual water

A repair sleeve or repair balloon can be implemented in order to prevent residual water from flowing into the fusion zones e.g. during repair work, connecting or tie-in work on HD-PE water pipes.

19.1. Repair sleeve



Image 166:

- **Repair sleeve RW**

For repairing HD-PE water pipes with d 32 to d 63 in a depressurised condition.

i INFO

The RW repair sleeve is only suitable for SDR 11 pipes!

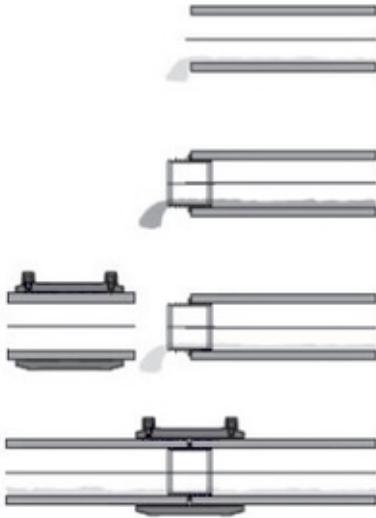

Image 167:

A fitting piece with two FRIALEN UB couplers and two RW repair sleeves must be prepared in order to repair the damaged HD-PE water pipe. The repair sleeves will prevent water from entering the fusion area of the FRIALEN couplers. The water pipe must be bent accordingly in order to assemble the fitting piece. Fusing can be commenced after positioning the FRIALEN UB coupler. The assembly area on the PE pipe must always be correctly prepared for electrofusion in accordance with the general assembly and installation requirements (mark and clean the fusion zone, remove the oxide layer etc.). Refer to Chapter 7. [Processing the FRIALEN safety fittings, P.18](#) and 8. [Assembly and processing: Couplers and moulded parts, P.26](#)

19.2. Repair Balloon



Image 168:

▪ RPS Repair Set

The repair balloon technology can be utilised to ensure a dry working area during repair work on damaged pipes or for connection joints for repairing HD-PE water pipes d 90 to d 900. Always observe the operating instructions for the FRIATOOLS RPS Repair Set, refer to Homepage <https://www.aliaxis.de/de/downloads>



Image 169:

The repair balloon is to be inserted into the pipe through a hole in the pipe wall.

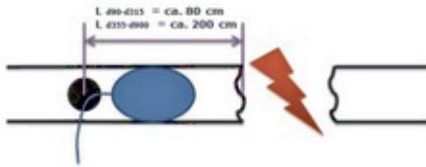

Image 170:

After inserting the repair balloon, it will be slowly inflated using the pump supplied with the repair set.

If the repair balloon has been positioned correctly in the pipe, then residual water will be prevented from leaking out.

After the integration, connection work or repair work, the repair balloon must always be removed from the pipe and the hole sealed with a saddle fitting.

20. Transition piece

20.1. About the product

FRIALEN transition pieces, transition adapters and transition elbows are utilised as material transitions from metallic components with a threaded connection (internal or external thread), such as fittings, or spigot end steel or copper pipes to a HD-PE connecting pipe.

The following material transitions can be implemented;

- HD-PE - Brass
- HD-PE - Stainless Steel (V2A)
- HD-PE - Steel
- HD-PE - Gunmetal
- HD-PE - Copper

Applications include gas networks and/or water supply as well as industrial applications.



Image 171:

The FRIALEN **Universal transition adapter** enables the position-independent assembly and a homogeneous fusion jointing with all suitable FRIALEN couplers and moulded parts (except FRIALONG and FRIASTOP long couplers).



Image 172:

In the case of FRIALEN **transition pieces** and **transition elbows** with male or female threads, a FRIALEN coupler or a FRIALEN elbow is integrated in the fitting.



Image 173:

In the case of FRIALEN **transition pieces** with steel or copper pipe spigot end and PE spigot end or coupler, the material transition is implemented on the metal side by fusion (steel) or brazing (copper) and on the PE side either with the integrated electrofusion coupler or, in the case of PE spigot end, with a FRIALEN coupler.

20.2. Product description

- **Universal transition adapter**

UAN		
HD-PE / Brass with male thread (brass) and PE pipe socket		
Maximum permissible working pressure	16 bar water	5 bar gas
Plastic material	PE 100	
Material, brass	CW617N / CW612N	
Thread	ISO 228	

UAM		
HD-PE / Brass with female thread (brass) and PE pipe socket		
Maximum permissible working pressure	16 bar water	5 bar gas
Plastic material	PE 100	
Material, brass	CW617N / CW612N	
Thread	ISO 228	

▪ **Transition piece and transition elbow**

USTN		
HD-PE / Steel with male thread (steel) and FRIALEN coupler		
Maximum permissible working pressure	-- Water	5 bar gas
Plastic material	PE 100	
Steel material	EN 10278, EN 10277-3 - 11SMn30+C	
Thread	EN 10226-1	

USTM		
HD-PE / Steel with female thread (steel) and FRIALEN coupler		
Maximum permissible working pressure	-- Water	5 bar gas
Plastic material	PE 100	
Steel material	EN 10278, EN 10277-3 - 11SMn30+C	
Thread	EN 10226-1	

MUN		
HD-PE / Steel with male thread (brass) and FRIALEN coupler		
Maximum permissible working pressure	16 bar water	-- Gas
Plastic material	PE 100	
Material, brass	EN 12168 - CW617N	
Thread	EN 10226-1	

MUN V2A		
HD-PE / V2A with male thread (stainless steel) and FRIALEN coupler		
Maximum permissible working pressure	16 bar water	-- Gas
Plastic material	PE 100	
Stainless steel material	V2A (EN 10278, EN 10088-3 - 1.4305 - X8CrNiS18-9)	
Thread	EN 10226-1	

MUM		
HD-PE / Gunmetal with female thread (gunmetal) and FRIALEN coupler		
Maximum permissible working pressure	16 bar water	-- Gas
Plastic material	PE 100	
Gunmetal material	EN 1982 - CC499K-GC	
Thread	EN 10226-1	

WUN 90		
HD-PE / Brass with male thread (brass) and FRIALEN 90° elbow		
Maximum permissible working pressure	16 bar water	-- Gas
Plastic material	PE 100	
Brass material	EN 12168 - CW617N	
Thread	EN 10226-1	

WUN V2A 90		
HD-PE / V2A with male thread (stainless steel) and FRIALEN 90° elbow		
Maximum permissible working pressure	16 bar water	-- Gas
Plastic material	PE 100	
Stainless steel material	EN 10278, EN 10088-3 - 1.4305 -X8CrNiS18-9	
Thread	EN 10226-1	

▪ Transition piece

USTR		
HD-PE / Steel pipe (pipe socket) and PE coupler		
Maximum permissible working pressure	-- Water	10 bar gas
Plastic material	PE 100	
Steel material	EN 10220 / EN 10216-1 - P235TR2	
Fusion, steel side	Arc welding	

USTRS		
HD-PE / Steel pipe spigot and PE pipe socket		
Maximum permissible working pressure	-- Water	10 bar gas
Plastic material	PE 100	
Steel material	ISO 3183 / API5L	
Fusion, steel side	Arc welding	

UFLG		
HD-PE / Copper (socket fitting) and PE coupler		
Maximum permissible working pressure	-- Water	5 bar gas
Plastic material	PE 100	
Copper material	SF Cu-F25, DIN EN 1057-R250	
Fusion, copper side	Brazing (coupler brazing)	

20.3. Assembling the transition piece

20.3.1. Assembling transition pieces with threaded connection

The screw connection (metal side) must always be initially executed for FRIALEN transition adapters, transition pieces and transition brackets with a screw thread.

i INFO

No assembly-related torsional forces may act on the fused PE pipe.

The screw-in forces are always to be applied with a spanner, applied to the union nut which has been previously installed at the factory.

The PE side is to be connected to a PE pipe using electrofusion.

The assembly area on the PE pipe must always be correctly prepared for electrofusion in accordance with the general assembly and installation requirements (mark and clean the fusion zone, remove the oxide layer etc.). Refer to Chapter 7. [Processing the FRIALEN safety fittings, P.18](#)

In the case of the FRIALEN transition adapter with PE pipe socket, please also observe the following for assembling the FRIALEN moulded part in the Chapter 8. [Assembly and processing: Couplers and moulded parts, P.26](#)

20.3.2. Assembling the transition piece with steel pipe and copper pipe

The fusion joint (metal side) will be initially executed by arc welding (steel pipe) or brazing (copper pipe) with FRIALEN steel pipe or copper pipe transition pieces.

i INFO

Shortening the steel pipe or copper pipe is not permitted, as the heat input during fusion/brazing jeopardises the sealing system.

i INFO

Care must always be taken to ensure that no fusion vapours and fusion beads enter the fusion area of the PE pipe when fusing the steel pipe.

The fusion ends of the FRIALEN steel pipe transition pieces are designed,

- as USTRS: in accordance with ASTM A106 and DIN EN ISO 3183
- as USTR: in accordance with ASTM A106/A106M-14 and DIN EN 10220/EN 10216-1

The PE side is to be connected to a PE pipe using electrofusion.

The assembly area on the PE pipe must always be correctly prepared for electrofusion in accordance with the general assembly and installation requirements (mark and clean the fusion zone, remove the oxide layer etc.). Refer to Chapter 7. [Processing the FRIALEN safety fittings, P.18](#)

In the case of the FRIALEN USTRS transition adapter with steel pipe spigot with PE pipe socket, please also observe the following for assembling the FRIALEN moulded part in the Chapter 8. [Assembly and processing: Couplers and moulded parts, P.26](#)

21. Fixation (FIXBLOC)

21.1. About the product



The FIXBLOC can always be utilised wherever high axial tensile and shear forces have to be absorbed. This is considered to be the case when e.g. relining pipes, creating fixed points and fixing work.

It can be used universally on HD-PE pipes in dimensions d 160 to d 1600 as a pull-in or pull-out protection, as a fixation or to create a fixed point. The strength per fixed point is 40 kN.

Image 174:

21.2. Product description



Image 175:

Standard processing:

The FIXBLOC can be assembled on a PE pipe using a standard tensioning belt. If an increased anchor force is required, then several FIXBLOC units can also be processed and installed on one pipe. The following requirements for the tensioning belt must therefore always be observed: belt width 50 mm, belt length approx. 3.5 x pipe diameter, or correspondingly longer for multiple applications.



Image 176:

Processing when utilising the FIXBLOC FWFB clamping unit:

The FIXBLOC can also be clamped on and fused from the pipe cutting edge with the FRIATOOLS FIXBLOC FWFB clamping unit process. This is a particularly helpful method when the pipe circumference is not accessible e.g. in the case of a PE liner in the sewer which must be anchored opposite the manhole wall.

21.3. Preparatory work, assembly and installation with the tensioning belt

The FIXBLOC will be applied with a commercially available tensioning belt or with the FIXBLOC FWFB clamping unit.

The assembly area on the PE pipe must always be correctly prepared for electrofusion in accordance with the general assembly and installation requirements (mark and clean the fusion zone, remove the oxide layer etc.). Refer to Chapter 7. [Processing the FRIALEN safety fittings, P.18](#)

I INFO

The described sequence of working steps must always be adhered to.

21.3.1. Assembling the FIXBLOC with the tensioning belt on the pipe

▲ CAUTION

The tensioning belt is always tensioned

Danger of injury

Failure of the tensioning belt can result in injuries. Always inspect the belt to ensure it is in perfect condition before using it and exchange it if necessary.



Image 177:

Position the FIXBLOC on the prepared pipe surface, guide the tensioning belt around the pipe and then thread the belt into the two loops of the FIXBLOC.

The FIXBLOC can also be utilised in multiple applications by applying several FIXBLOC units around the pipe.



Image 178:

Insert the end of the tensioning belt into the belt ratchet and then secure the FIXBLOC to the pipe by operating the belt ratchet.

i INFO

The clamping lever of the ratchet must be locked in the closed position again after the assembly has been completed.

i INFO

Selecting the tensioning belt!

Always utilise tensioning belts with a belt width of 50 mm and a minimum length of approx. 3.5 x pipe diameter. The belt length must be adjusted for multiple applications accordingly.



Image 179:

The FIXBLOC must now be positioned on the pipe without any gaps.

Always inspect, correct if necessary, the correct position of the FIXBLOC as well as the gap-free positioning on the pipe!

21.3.2. Fusion



Image 180:

Always observe the working steps for executing the fusion process (contacting the fusion unit, reading in the barcode and starting the fusion process, marking of the fusion joint etc.). Refer to Chapter 8.2. [Fusion process, P.27](#)

i INFO

The barcode which is required for fusion is attached on a belt on the component.

After the fusing time has elapsed, the fusion unit can be switched off and the fusing cable can be disconnected.

The FIXBLOC must remain tensioned during the cooling time. The tensioning belt can be dismantled when the cooling time has elapsed.

i INFO

Always comply with the cooling times!

Always observe the CT details provided on the barcode! If the cooling time is not complied with, then the anchoring force for the FIXBLOC can be considerably reduced.

21.3.3. Dismantling the tensioning belt

After the cooling time (CT) has elapsed: Release the belt by opening the belt ratchet. Remove the tensioning belt from the FIXBLOC.

21.4. Preparatory work, assembly and installation with the clamping unit

When it is not possible to install the FIXBLOC by using the tensioning belt e.g. because the pipe circumference is not freely accessible, then the FIXBLOC FWFB clamping unit must be utilised in order to clamp the FIXBLOC.

The assembly area on the PE pipe must always be correctly prepared for electrofusion in accordance with the general assembly and installation requirements (mark and clean the fusion zone, remove the oxide layer etc.). Refer to Chapter 7. [Processing the FRIALEN safety fittings, P.18](#)

i INFO

The described sequence of working steps must always be adhered to.

21.4.1. Assembling the FIXBLOC with the clamping unit on the pipe

i INFO

Attention: Always read the provided barcode!

Always read the fusion barcode **before** assembling the fixing plate because the plate conceals the barcode sticker.



Image 181:

Assembling the fixing plate on the FIXBLOC.

Always ensure that the two guide rails located on the fixing plate are positioned on the two outer bars of the FIXBLOC when assembling the fixing plate on the FIXBLOC.



Image 182:

Position the FIXBLOC with the pre-assembled fixing plate on the pipe surface.

Subsequently assemble the first of the three screw clamps to the centre position of the fixing plate. A guide has been provided on the fixing plate for easier screw clamp assembly.

The FIXBLOC will be firmly positioned on the pipe by turning the handle of the screw clamp.

i INFO

Always inspect the correct position of the FIXBLOC on the pipe after fitting the first screw clamp!



Image 183:

Subsequently assemble both remaining screw clamps on the external positions of the fixing plate.

Guides have been provided on the fixing plate for assembling the screw clamps on the two external assembly positions.

i INFO

Always ensure that the centre screw clamp does not loosen when tightening the two external screw clamps. Tighten this again when necessary.



Image 184:

Turning the handles with a ratchet, wrench or spanner will ensure that the FIXBLOC is correctly applied on the pipe surface without leaving any gaps.

The FIXBLOC is considered to be correctly assembled on the pipe when both external guides are resting on the pipe.

The FIXBLOC must now be positioned on the pipe without any gaps.

i INFO



Image 185:

Always ensure that the threaded spindle has the largest possible stroke (maximum clamping width of the clamping arms) when assembling the external screw clamps.

This will guarantee that even larger gaps between the FIXBLOC and the pipe can be bridged.

i INFO

Before commencing the fusion process, always inspect the correct position of the FIXBLOC as well as ensuring that there are no gaps on the pipe and correct them if necessary!

21.4.2. Fusion



Always observe the working steps for executing the fusion process (contacting the fusion unit, **Attention: the barcode has already been read!** and starting the fusion process, marking of the fusion joint etc.). Refer to Chapter [8.2. Fusion process, P.27](#)

Image 186:

After the fusing time has elapsed, the fusion unit can be switched off and the fusing cable can be disconnected.

The FIXBLOC must remain tensioned during the cooling time. The FIXBLOC FWFB clamping unit can be dismantled when the cooling time has elapsed.

i INFO

Always comply with the cooling times!

Always observe the CT details provided on the barcode! If the cooling time is not complied with, then the anchoring force for the FIXBLOC can be considerably reduced.

21.4.3. Dismantling the clamping unit

⚠ CAUTION

The fixing plate is always tensioned

Danger of injury when opening the screw clamps.
Always open the screw clamps slowly!

The clamping pressure is discharged from the FIXBLOC by turning the handles of the screw clamps. After opening the screw clamps, they can be removed from the guide rails on the fixing plate.

Always subsequently store the components of the FIXBLOC FWFB clamping unit in the transport box in a clean and dry place.

Aliaxis Deutschland GmbH

Infrastructure
Steinzeugstraße 50
68229 Mannheim
Tel +49 621 486-2828
Fax +49 621 486-1598
info.de@alixis.com
www.alixis.de

